

# **RIGOL**

## **User's Guide**

### **DP700 Series Programmable Linear DC Power Supply**

**Apr. 2016**

**RIGOL TECHNOLOGIES, INC.**



# Guaranty and Declaration

## Copyright

© 2016 **RIGOL** TECHNOLOGIES, INC. All Rights Reserved.

## Trademark Information

**RIGOL** is a registered trademark of **RIGOL** TECHNOLOGIES, INC.

## Publication Number

UGH05101-1110

## Software Version

00.01.02

Software upgrade might change or add product features. Please acquire the latest version of the manual from **RIGOL** website or contact **RIGOL** to upgrade the software.

## Notices

- **RIGOL** products are covered by P.R.C. and foreign patents, issued and pending.
- **RIGOL** reserves the right to modify or change parts of or all the specifications and pricing policies at the company's sole decision.
- Information in this publication replaces all previously released materials.
- Information in this publication is subject to change without notice.
- **RIGOL** shall not be liable for either incidental or consequential losses in connection with the furnishing, use, or performance of this manual, as well as any information contained.
- Any part of this document is forbidden to be copied, photocopied, or rearranged without prior written approval of **RIGOL**.

## Product Certification

**RIGOL** guarantees that this product conforms to the national and industrial standards in China as well as the ISO9001:2008 standard and the ISO14001:2004 standard. Other international standard conformance certifications are in progress.

## Contact Us

If you have any problem or requirement when using our products or this manual, please contact **RIGOL**.

E-mail: [service@rigol.com](mailto:service@rigol.com)

Website: [www.rigol.com](http://www.rigol.com)

# Safety Requirement

## General Safety Summary

Please review the following safety precautions carefully before putting the instrument into operation so as to avoid any personal injury or damage to the instrument and any product connected to it. To prevent potential hazards, please follow the instructions specified in this manual to use the instrument properly.

### **Use Proper Power Cord.**

Only the exclusive power cord designed for the instrument and authorized for use within the local country could be used.

### **Ground the Instrument.**

The instrument is grounded through the Protective Earth lead of the power cord. To avoid electric shock, connect the earth terminal of the power cord to the Protective Earth terminal before connecting any input or output terminals.

### **Connect the Probe Correctly.**

If a probe is used, the probe ground lead must be connected to earth ground. Do not connect the ground lead to high voltage. Improper way of connection could result in dangerous voltages being present on the connectors, controls or other surfaces of the oscilloscope and probes, which will cause potential hazards for operators.

### **Observe All Terminal Ratings.**

To avoid fire or shock hazard, observe all ratings and markers on the instrument and check your manual for more information about ratings before connecting the instrument.

### **Use Proper Overvoltage Protection.**

Ensure that no overvoltage (such as that caused by a bolt of lightning) can reach the product. Otherwise, the operator might be exposed to the danger of an electric shock.

### **Do Not Operate Without Covers.**

Do not operate the instrument with covers or panels removed.

### **Do Not Insert Objects Into the Air Outlet.**

Do not insert objects into the air outlet, as doing so may cause damage to the instrument.

### **Use Proper Fuse.**

Please use the specified fuses.

**Avoid Circuit or Wire Exposure.**

Do not touch exposed junctions and components when the unit is powered on.

**Do Not Operate With Suspected Failures.**

If you suspect that any damage may occur to the instrument, have it inspected by **RIGOL** authorized personnel before further operations. Any maintenance, adjustment or replacement especially to circuits or accessories must be performed by **RIGOL** authorized personnel.

**Provide Adequate Ventilation.**

Inadequate ventilation may cause an increase of temperature in the instrument, which would cause damage to the instrument. So please keep the instrument well ventilated and inspect the air outlet and the fan regularly.

**Do Not Operate in Wet Conditions.**

To avoid short circuit inside the instrument or electric shock, never operate the instrument in a humid environment.

**Do Not Operate in an Explosive Atmosphere.**

To avoid personal injuries or damage to the instrument, never operate the instrument in an explosive atmosphere.

**Keep Product Surfaces Clean and Dry.**

To avoid dust or moisture from affecting the performance of the instrument, keep the surfaces of the instrument clean and dry.

**Prevent Electrostatic Impact.**

Operate the instrument in an electrostatic discharge protective environment to avoid damage induced by static discharges. Always ground both the internal and external conductors of cables to release static before making connections.

**Use the Battery Properly.**

Do not expose the battery (if available) to high temperature or fire. Keep it out of the reach of children. Improper change of a battery (lithium battery) may cause an explosion. Use the **RIGOL** specified battery only.

**Handle with Caution.**

Please handle with care during transportation to avoid damage to keys, knobs, interfaces, and other parts on the panels.

**Do Not Use this Instrument to Provide Power for the Active Load.**

The backflow current may cause the power control loop to be out of control, which could further damage the devices that receives the power supply from this instrument. Therefore, this instrument is only allowed to provide power for the pure load that does not have the current output function.

## Safety Notices and Symbols

### Safety Notices in this Manual:



---

**WARNING**

Indicates a potentially hazardous situation or practice which, if not avoided, will result in serious injury or death.

---



---

**CAUTION**

Indicates a potentially hazardous situation or practice which, if not avoided, could result in damage to the product or loss of important data.

---

### Safety Terms on the Product:

**DANGER** It calls attention to an operation, if not correctly performed, could result in injury or hazard immediately.

**WARNING** It calls attention to an operation, if not correctly performed, could result in potential injury or hazard.

**CAUTION** It calls attention to an operation, if not correctly performed, could result in damage to the product or other devices connected to the product.

### Safety Symbols on the Product:



Hazardous Voltage



Safety Warning



Protective Earth Terminal



Chassis Ground



Test Ground

---

## Allgemeine Sicherheits Informationen

Überprüfen Sie die folgenden Sicherheitshinweise sorgfältig um Personenschäden oder Schäden am Gerät und an damit verbundenen weiteren Geräten zu vermeiden. Zur Vermeidung von Gefahren, nutzen Sie bitte das Gerät nur so, wie in diesem Handbuch angegeben.

### **Um Feuer oder Verletzungen zu vermeiden, verwenden Sie ein ordnungsgemäßes Netzkabel.**

Verwenden Sie für dieses Gerät nur das für ihr Land zugelassene und genehmigte Netzkabel.

### **Erden des Gerätes.**

Das Gerät ist durch den Schutzleiter im Netzkabel geerdet. Um Gefahren durch elektrischen Schlag zu vermeiden, ist es unerlässlich, die Erdung durchzuführen. Erst dann dürfen weitere Ein- oder Ausgänge verbunden werden.

### **Anschluss eines Tastkopfes.**

Die Erdungsklemmen der Sonden sind auf dem gleichen Spannungspegel des Instruments geerdet. Schließen Sie die Erdungsklemmen an keine hohe Spannung an.

### **Beachten Sie alle Anschlüsse.**

Zur Vermeidung von Feuer oder Stromschlag, beachten Sie alle Bemerkungen und Markierungen auf dem Instrument. Befolgen Sie die Bedienungsanleitung für weitere Informationen, bevor Sie weitere Anschlüsse an das Instrument legen.

### **Verwenden Sie einen geeigneten Überspannungsschutz.**

Stellen Sie sicher, daß keinerlei Überspannung (wie z.B. durch Gewitter verursacht) das Gerät erreichen kann. Andernfalls besteht für den Anwender die Gefahr eines Stromschlages.

### **Nicht ohne Abdeckung einschalten.**

Betreiben Sie das Gerät nicht mit entfernten Gehäuse-Abdeckungen.

### **Betreiben Sie das Gerät nicht geöffnet.**

Der Betrieb mit offenen oder entfernten Gehäuseteilen ist nicht zulässig. Nichts in entsprechende Öffnungen stecken (Lüfter z.B.)

### **Passende Sicherung verwenden.**

Setzen Sie nur die spezifikationsgemäßen Sicherungen ein.

### **Vermeiden Sie ungeschützte Verbindungen.**

Berühren Sie keine unisolierten Verbindungen oder Baugruppen, während das Gerät in Betrieb ist.

### **Betreiben Sie das Gerät nicht im Fehlerfall.**

Wenn Sie am Gerät einen Defekt vermuten, sorgen Sie dafür, bevor Sie das Gerät wieder betreiben, dass eine Untersuchung durch **RIGOL** autorisiertem Personal durchgeführt wird. Jedwede Wartung, Einstellarbeiten oder Austausch von Teilen am Gerät, sowie am Zubehör dürfen nur von **RIGOL** autorisiertem Personal durchgeführt werden.

### **Belüftung sicherstellen.**

Unzureichende Belüftung kann zu Temperaturanstiegen und somit zu thermischen Schäden am Gerät führen. Stellen Sie deswegen die Belüftung sicher und kontrollieren regelmäßig Lüfter und Belüftungsöffnungen.

### **Nicht in feuchter Umgebung betreiben.**

Zur Vermeidung von Kurzschluß im Geräteinneren und Stromschlag betreiben Sie das Gerät bitte niemals in feuchter Umgebung.

### **Nicht in explosiver Atmosphäre betreiben.**

Zur Vermeidung von Personen- und Sachschäden ist es unumgänglich, das Gerät ausschließlich fernab jedweder explosiven Atmosphäre zu betreiben.

### **Geräteoberflächen sauber und trocken halten.**

Um den Einfluß von Staub und Feuchtigkeit aus der Luft auszuschließen, halten Sie bitte die Geräteoberflächen sauber und trocken.

### **Schutz gegen elektrostatische Entladung (ESD).**

Sorgen Sie für eine elektrostatisch geschützte Umgebung, um somit Schäden und Funktionsstörungen durch ESD zu vermeiden. Erden Sie vor dem Anschluß immer Innen- und Außenleiter der Verbindungsleitung, um statische Aufladung zu entladen.

### **Die richtige Verwendung des Akku.**

Wenn eine Batterie verwendet wird, vermeiden Sie hohe Temperaturen bzw. Feuer ausgesetzt werden. Bewahren Sie es außerhalb der Reichweite von Kindern auf. Unsachgemäße Änderung der Batterie (Anmerkung: Lithium-Batterie) kann zu einer Explosion führen. Verwenden Sie nur von **RIGOL** angegebene Akkus.

### **Sicherer Transport.**

Transportieren Sie das Gerät sorgfältig (Verpackung!), um Schäden an Bedienelementen, Anschlüssen und anderen Teilen zu vermeiden.

### **Vermeiden Sie das Einprägen von Strom und Spannung an den Testklemmen.**

Das DP700 Power Supply kann hierdurch zerstört werden, keine aktive Last. Das DP800A kann nur Strom und Spannungen liefern.



## Sicherheits Begriffe und Symbole

### Begriffe in diesem Guide:

**WARNING**

Die Kennzeichnung WARNING beschreibt Gefahrenquellen die leibliche Schäden oder den Tod von Personen zur Folge haben können.

**CAUTION**

Die Kennzeichnung Caution (Vorsicht) beschreibt Gefahrenquellen die Schäden am Gerät hervorrufen können.

### Begriffe auf dem Produkt:

**DANGER** weist auf eine Verletzung oder Gefährdung hin, die sofort geschehen kann.

**WARNING** weist auf eine Verletzung oder Gefährdung hin, die möglicherweise nicht sofort geschehen.

**CAUTION** weist auf eine Verletzung oder Gefährdung hin und bedeutet, dass eine mögliche Beschädigung des Instruments oder anderer Gegenstände auftreten kann.

### Symbole auf dem Produkt:



Gefährliche  
Spannung



Sicherheits-  
Hinweis



Schutz-erde



Gehäusemasse



Erde

## Care and Cleaning

### Care

Do not store or leave the instrument where it may be exposed to direct sunlight for long periods of time.

### Cleaning

Clean the instrument regularly according to its operating conditions.

1. Disconnect the instrument from all power sources.
2. Clean the external surfaces of the instrument with a soft cloth dampened with mild detergent or water. When cleaning the LCD, take care to avoid scarifying it.



#### CAUTION

To avoid damage to the instrument, do not expose it to caustic liquids.

---



#### WARNING

To avoid short-circuit resulting from moisture or personal injuries, ensure that the instrument is completely dry before connecting it to the power supply.

---

## Environmental Considerations

The following symbol indicates that this product complies with the WEEE Directive 2002/96/EC.



### Product End-of-Life Handling

The equipment may contain substances that could be harmful to the environment or human health. To avoid the release of such substances into the environment and avoid harm to human health, we recommend you to recycle this product appropriately to ensure that most materials are reused or recycled properly. Please contact your local authorities for disposal or recycling information.

**From:** RIGOL Technologies Inc

Date: May 5, 2014

156# Cai He Village, Sha He Town, Chang Ping District, Beijing, China

<http://www.rigol.com>

**Declaration of RoHS&WEEE Conformity**

**RoHS:** The European Union of 2011/65/EU Restriction of Hazardous Substances (RoHS) Directive, which applies to all electrical products and their component parts, offered for sale into the European Union after July 22, 2014, restricts the presence of the six substances: Lead (Pb), Cadmium (Cd), Mercury (Hg), Hexavalent Chromium (Cr<sup>6+</sup>), Polybrominated biphenylethers (PBBs), and Polybrominated diphenylethers (PBDEs). In view of legal and market requirements, Rigol has restricted use of Pb, Cd, Hg, Cr<sup>6+</sup>, PBBs, PBDEs in our products. In addition, we require all our direct suppliers to strictly limit or prohibit use of hazardous substances. All its AVL (Approved Vendors List) components apply for RoHS.

**Content of Compliance**

Lead	<0.1% by weight (1000 ppm)	Mercury	<0.1% by weight (1000 ppm)
Cadmium	<0.01% by weight (100 ppm)	Hexavalent Chrome (Cr <sup>6+</sup> )	<0.1% by weight (1000 ppm)
PBBs	<0.1% by weight (1000 ppm)	PBDEs	<0.1% by weight (1000 ppm)

**WEEE:** The European Union of 2012/19/EU, Waste Electrical and Electronic Equipment percentage of reused, recycled and recovered materials, such as metals, plastics, and components of waste electrical and electronic equipment.

We are registered in Germany in the WEEE (in Germany, EAR) register as a manufacturer of category 9 (monitoring and control) equipment and have the assigned registration number

WEEE-Reg.-No. : DE88132002

in our commercial documents.

RIGOL Technologies Inc

Weiming Mao  
 Director of Central Quality and  
 Environmental Management



## DP700 Series Overview

DP700 series power supply is a type of affordable programmable linear DC power supply with high performance. With superb performance specifications, pure and reliable output, and clear user interface, the DP700 series supports timing output and trigger function, and provides a remote communication interface, enabling you to meet your diversified test requirements.

### Main Features:

- DP711: single output, 30 V/5 A, total power up to 150 W
- DP712: single output, 50 V/3 A, total power up to 150 W
- Low ripple and noise:  
DP711: <500  $\mu$ Vrms/3 mVpp, <2 mArms  
DP712: <500  $\mu$ Vrms/4 mVpp, <2 mArms
- Excellent load and line regulation rate: <0.01% + 2 mV; <0.01% + 2 mA
- Transient response time: <50  $\mu$ s
- 1 mV/1 mA resolution (optional)
- Sound overvoltage/overcurrent/overtemperature protection, with the response time for the overvoltage protection less than 10 ms
- External trigger function supported, enabling synchronous output for multiple devices
- Timing output supported (10 ms to 99999 s) for up to 2,048 groups
- 3.5-inch TFT-LCD; compact and elegant; easy to use
- Front panel locking and any specified key locking supported
- RS232 interface communication supported

# Document Overview

## Chapter 1 Quick Start

This chapter introduces some basic information that you should know when you use the DP700 series power supply for the first time. It contains the following contents: out-of-box inspection method, the appearance and dimensions of the instrument, descriptions of the front/rear panel, how to connect the instrument to the AC power, how to carry out the power-on inspection, how to replace the fuse, a brief introduction about the user interface, and how to set the parameters.

## Chapter 2 Front Panel Operations

This chapter introduces what functions can be realized through the front panel operations and the operation methods.

## Chapter 3 Remote Control

This chapter introduces how to remotely control the instrument.

## Chapter 4 Troubleshooting

This chapter introduces the possible failures and solutions in using the DP700 series power supply.

## Chapter 5 Specifications

This chapter lists the specifications of the DP700 series power supply.

## Chapter 6 Appendix

This chapter provides order information and warranty information of the DP700 series power supply.

## Index

This chapter provides keyword search information, enabling you to quickly locate the desired information.

### Tip

For the latest version of this manual, download it from the official website of **RIGOL** ([www.rigol.com](http://www.rigol.com)).

## Format Conventions in this Manual

### Key

- (1) The key on the front panel is denoted by the format of "Key Name (Bold) + Text Box" in the manual. For example, **On/Off** denotes the "On/Off" key.
- (2) Use the screen shot to indicate the key. For example,  denotes the Power key.

**Content Conventions in this Manual**

DP700 series programmable linear DC power supply includes the following models. Unless otherwise specified, this manual takes DP711 as an example to illustrate the functions and operation methods of the DP700 series.

<b>Model</b>	<b>No. of Channels</b>	<b>Output Voltage/Current</b>
DP711	1	30 V/5 A
DP712	1	50 V/3 A

# Contents

<b>Guaranty and Declaration .....</b>	<b>I</b>
<b>Safety Requirement .....</b>	<b>II</b>
General Safety Summary.....	II
Safety Notices and Symbols.....	IV
Allgemeine Sicherheits Informationen.....	V
Sicherheits Begriffe und Symbole .....	VII
Care and Cleaning .....	VIII
Environmental Considerations.....	VIII
<b>DP700 Series Overview.....</b>	<b>X</b>
<b>Document Overview.....</b>	<b>XI</b>
<b>Chapter 1 Quick Start .....</b>	<b>1-1</b>
General Inspection .....	1-2
Appearance and Dimensions.....	1-3
Front Panel.....	1-4
Rear Panel.....	1-10
User Interface.....	1-12
Power-on Inspection.....	1-14
Fuse Replacement .....	1-17
Built-in Help Information .....	1-17
Parameter Setting Method.....	1-18
<b>Chapter 2 Front Panel Operations .....</b>	<b>2-1</b>
Constant Voltage Output .....	2-2
Constant Current Output.....	2-5
Power Supply in Series and Parallel Connection .....	2-8
Power Supply in Series Connection .....	2-8
Power Supply in Parallel Connection.....	2-9
Timer .....	2-10
Set Timer Parameters.....	2-11
Enable the Timing Output .....	2-14
Trigger .....	2-16
Trigger Input.....	2-16
Trigger Output.....	2-17
Synchronous Output.....	2-17
Store and Recall.....	2-20
Manage Files .....	2-21
Restore Default Settings .....	2-24
Clear All Saved Files .....	2-25
System Utility Function .....	2-26
System Setting .....	2-27
RS232 Interface Setting.....	2-30

---

System Information .....	2-32
Test and Calibration .....	2-33
Option Configuration.....	2-35
Remote Locking .....	2-37
Front Panel Locking .....	2-37
Key Locking .....	2-38
<b>Chapter 3 Remote Control .....</b>	<b>3-1</b>
<b>Chapter 4 Troubleshooting .....</b>	<b>4-1</b>
<b>Chapter 5 Specifications .....</b>	<b>5-1</b>
<b>Chapter 6 Appendix .....</b>	<b>6-1</b>
Appendix A: Order Information.....	6-1
Appendix B: Warranty.....	6-2
<b>Index.....</b>	<b>1</b>



# Chapter 1 Quick Start

Contents in this chapter:

- General Inspection
- Appearance and Dimensions
- Front Panel
- Rear Panel
- User Interface
- Power-on Inspection
- Fuse Replacement
- Built-in Help Information
- Parameter Setting Method

## General Inspection

### 1. Inspect the packaging

If the packaging has been damaged, do not dispose the damaged packaging or cushioning materials until the shipment has been checked for completeness and has passed both electrical and mechanical tests.

The consigner or carrier shall be liable for the damage to the instrument resulting from shipment. **RIGOL** would not be responsible for free maintenance/rework or replacement of the instrument.

### 2. Inspect the instrument

In case of any mechanical damage, missing parts, or failure in passing the electrical and mechanical tests, contact your **RIGOL** sales representative.

### 3. Check the accessories

Please check the accessories according to the packing lists. If the accessories are damaged or incomplete, please contact your **RIGOL** sales representative.

# Appearance and Dimensions

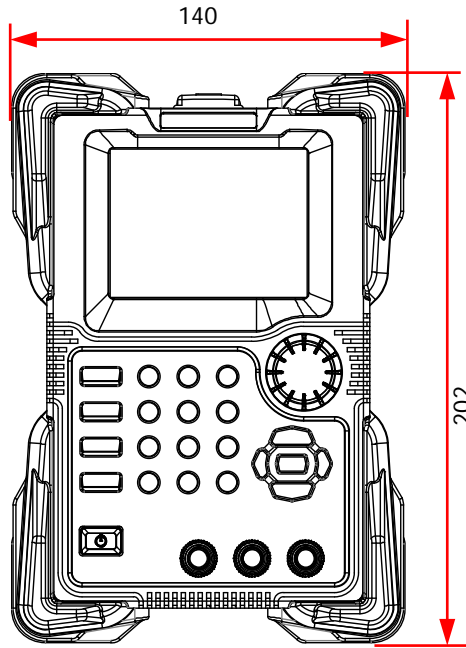

Figure 1-1 Front View

Unit: mm

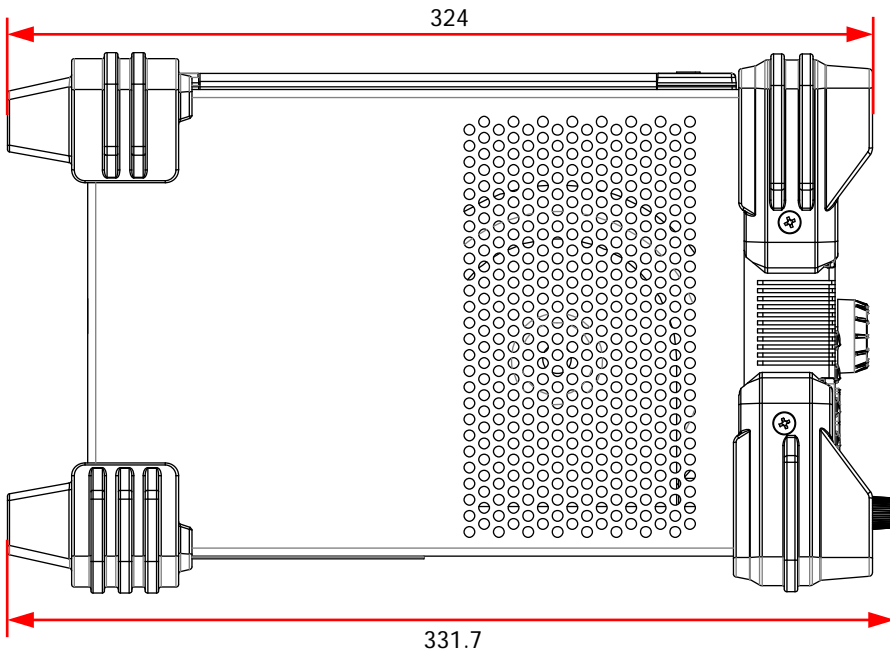

Figure 1-2 Side View

Unit: mm

# Front Panel

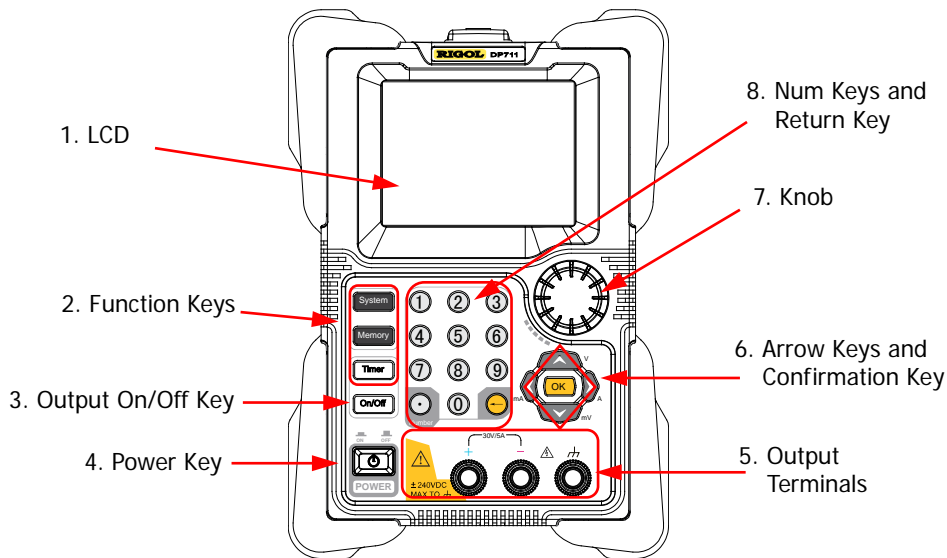

Figure 1-3 Front Panel

## 1. LCD

3.5-inch TFT-LCD. It is used to display the parameter setting, output status, help information, prompt message, etc.

## 2. Function Keys

### 2.1 System utility function key

**System**

- (1) System setting  
Set the system language, power-on setting, and brightness; turn on or off the beeper and screen saver; enable the trigger input and trigger output.
- (2) RS232 interface setting  
Set baud rate and parity; view stop bit and data bit.
- (3) System information  
View the device model, serial number, and software version.
- (4) Test and calibration
  - View the test information: fan state.
  - View the auto calibration information: the auto calibration status and the last auto calibration time.
  - Perform manual calibration for voltage DAC calibration,

current DAC calibration, voltage ADC calibration, current ADC calibration, and OVP calibration.

- (5) Option configuration
  - View the installation status of the options, such as Trigger, Timer, and High Resolution.
  - Install the options. For the installation methods, refer to "**Option Configuration**".

## 2.2 Storing and recalling operation key

### Memory

- (1) Restore the instrument settings to defaults.  
For default settings, refer to Table 2-3.
- (2) Clear all saved files.  
Clear all saved state files and timer files.
- (3) Store, recall, or delete files.  
The DP700 series can store up to 10 state files and 2 timer files.

## 2.3 Timer key

### Timer

- (1) Set parameters for timer: the number of output groups, the number of cycles, trigger mode, end state, output voltage, output current, and duration time.  
**Note:** When you press **Timer** to enter the timer interface, the channel output is automatically disabled.
- (2) Close the timer and return to the main interface.  
During the timing output, press **Timer** and select "YES" to close the timer and return to the main interface.

## 3. Output On/Off Key

### On/Off

- (1) Enable or disable the channel output.  
In the main interface or other function interfaces (including the system utility function interface, store and recall interface; excluding the timer interface), the **On/Off** key is used to enable/disable the channel output.
- (2) Enable or disable the timing output.
  - In the timer interface, after setting the parameters for the timer, press **On/Off** to enable the timing output.
  - During the timing output, press **On/Off** to disable the

timing output. When you press **On/Off** again, the system will start to make output from the first group of parameters.

#### 4. Power Key

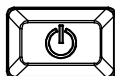

Turn on or off the instrument.

#### 5. Output Terminals

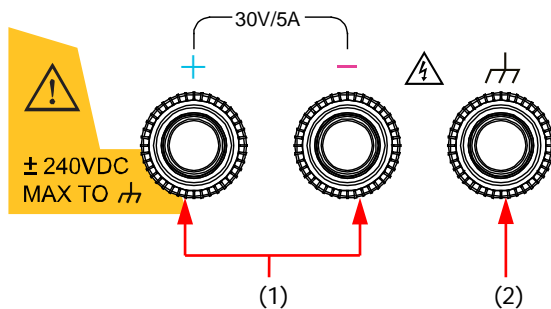

(1) Channel output terminals: connect with the load, which are used to output the voltage and current.

**Note:** Connect the positive terminal of the load with the (+) terminal of the channel output and connect the negative terminal of the load with the (-) terminal of the channel output.

(2) Ground terminal: connects with the instrument chassis and ground lead (power cord ground terminal), which is in the grounded state.

**Note:** The voltage to ground of any channel output terminal (+ or -) cannot exceed  $\pm 240$  Vdc.

### Connection Methods for the Output Terminals:

#### Method 1:

Connect the test lead to Position A of the output terminal.

#### Method 2:

Rotate the outer nut of the output terminal counterclockwise and connect the test lead to Position B of the output terminal; then, rotate the outer nut of the output terminal clockwise and fasten it firmly.

The second connection method can avoid the error arising from the resistance of the output terminal. Method 2 is recommended when the output current of the channel is relatively greater.

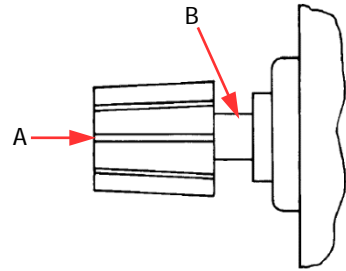

## 6. Arrow Keys and Confirmation Key

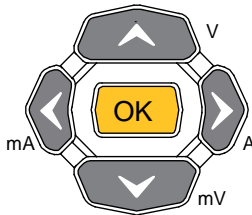

**Note:** Pressing arrow keys or **OK** in different interfaces can produce different operation results. Here introduces their common usage. As for their other functions and usages, refer to the detailed introduction described in later sections of the manual. You can also refer to the help information at the bottom of the instrument interface.

### 6.1 Arrow keys (Up/Down/Left/Right key)

- (1) Switch the parameter focus.
- (2) Move the cursor.
- (3) Switch the parameters or parameter values.
- (4) Select the voltage/current unit.  
Press the Up/Down arrow key to select V/mV as the voltage unit; press the Left/Right arrow key to select mA/A as the current unit.
- (5) Switch the tab.  
Press **System** to enter the system utility function interface, and press the Left/Right arrow key to select different tabs.

## 6.2 Confirmation key



- (1) Confirm the currently selected item.
- (2) Enable/disable the specified function, such as overvoltage protection (OVP) and overcurrent protection (OCP).
- (3) Select the default voltage unit (V) and the default current unit (A).
- (4) Control the timing output.

When the trigger mode of the timer is set to "Single", one single press on **OK** enables a single output based on one group of timing parameters, until the instrument has completed outputting operation for a specified number of times (total number of output groups).

## 7. Knob

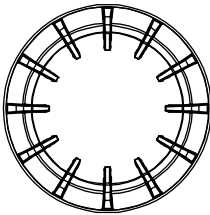

**Note:** Rotating the knob in different interfaces can produce different operation results. Here introduces its common usage. As for its other functions and usages, refer to the detailed introduction described in later sections of the manual. You can also refer to the help information at the bottom of the instrument interface.

- (1) Switch the parameter focus.
- (2) Modify the value where the cursor stays.
- (3) Switch the parameters or parameter values.
- (4) Enter a negative measurement value.  
During the manual calibration process, you can use the knob to enter a negative measurement value.
- (5) Switch the tab.  
Press **System** to enter the system utility function interface, and rotate the knob to select different tabs.



## 8. Num Keys and Return Key

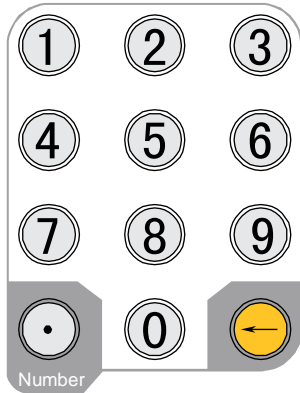

### 8.1 Num keys

The num keys contain numbers (0-9) and a dot. You can use the num keys to enter a value.

### 8.2 Return key



- (1) Delete the unwanted characters that have been entered.
- (2) Cancel the specified operation.
- (3) Return to the local mode.  
When the instrument is in the remote mode, press this key to return to the local mode.
- (4) Enter the upgrade interface.  
For the software upgrade, when the welcome interface is displayed on the screen, press  to enter the upgrade interface.

## Rear Panel

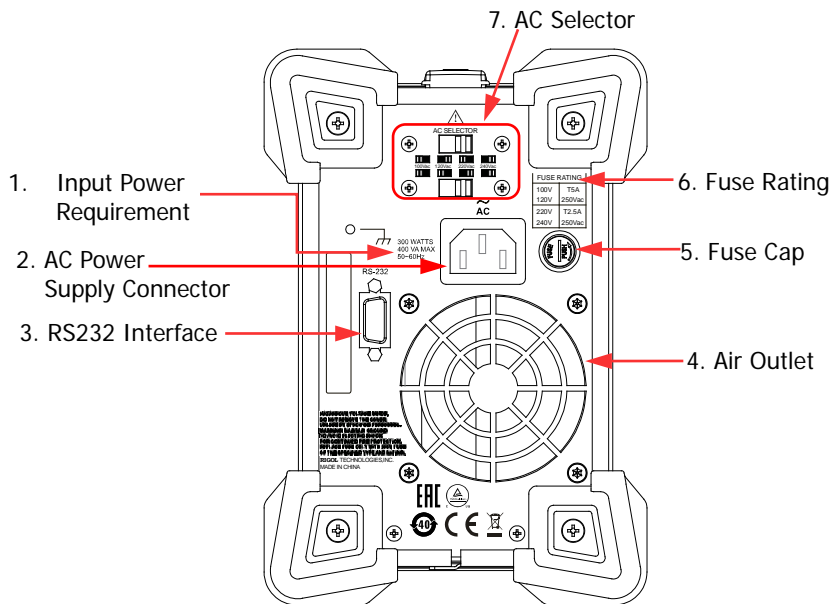

Figure 1-4 Rear Panel

### 1. Input Power Requirement

The requirement for the power and frequency of the AC input power.

### 2. AC Power Supply Connector

Plug the specified power cord available in the accessories into the AC power supply connector of the instrument, and then connect the instrument to the AC power.

### 3. RS232 Interface

You can remotely control the DP700 series power supply via the interface.

Pin 7 and Pin 8 of the RS232 interface are not used in remote communication. They are used in the trigger function. Trigger is an optional function. If you want to use the trigger function, order the trigger option based on the Order No. available in "**Appendix A: Order Information**", and then install the option by referring to "**Option Configuration**".

### 4. Air Outlet

Decrease the temperature inside the instrument to ensure its performance. When you place the instrument on the workbench or install it into the rack, keep the air outlet from a distance of 10 cm to ensure adequate ventilation.

### 5. Fuse Cap

When leaving the factory, the instrument has installed a fuse that conforms to

the standard of the destination country. For fuse replacement, refer to "**Fuse Replacement**".

## 6. Fuse Rating

List the input voltage and its matched fuse specification.

## 7. AC Selector

Select the voltage rating that matches the actual AC input power. For the matching relationship, refer to "**Fuse Rating**" on the rear panel or Table 1-2.

When the switch lever (including the top switch lever and the bottom switch lever) is located at a different position, it indicates that a different voltage rating is selected. For example, in the following figure, 220 Vac is selected.

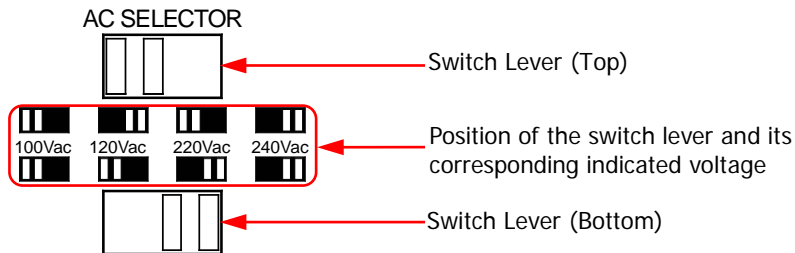

## User Interface

The user interface of the DP700 series power supply consists of the main interface and the function interface. In the main interface, you can set and view the information about the channel output; in the function interface, you can set and view the information about the functions. When the instrument powers on, it enters the main interface by default. This section mainly introduces the main interface of the DP700 series power supply. The function interface will be introduced in "**Front Panel Operations**".

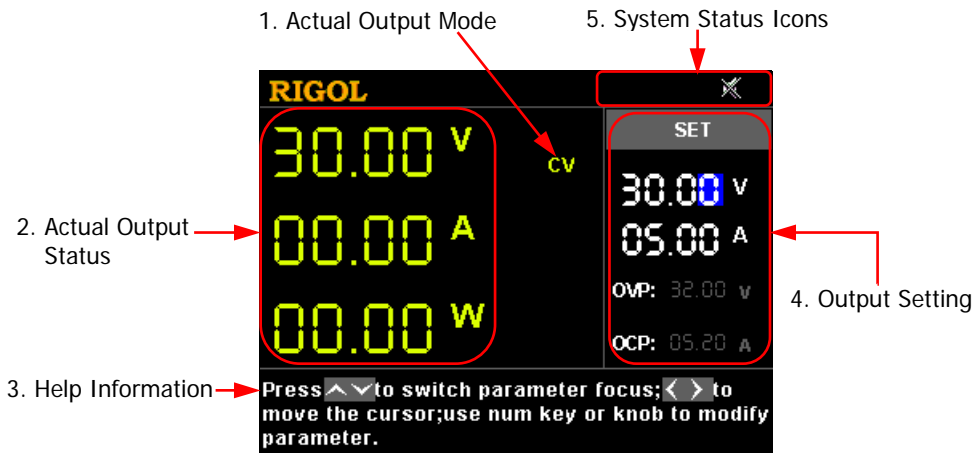







Figure 1-5 Main Interface

Table 1-1 Main Interface Description

No.	Name	Description
1	Actual Output Mode	Displays the channel output mode in real time: CV (constant voltage), CC (constant current), or UR (unregulated).
2	Actual Output Status	Displays the actual output status of the channel in real time, including the actual output voltage (V), the actual output current (A), and the actual output power (W).
3	Help Information	Displays the help information of the current interface in real time, including the interface description, operation method, etc.
4	Output Setting	Sets the channel output parameters, including output voltage, output current, the on/off status of overvoltage protection, overvoltage protection setting value, the on/off status of overcurrent protection, and overcurrent protection setting value.
5	System Status Icons	<p> <b>OTP</b>: indicates that the overtemperature protection occurred.</p> <p>: indicates that the front panel has been locked.</p> <p>: indicates that the beeper is off.</p> <p>: indicates that the beeper is on.</p> <p>: indicates that the instrument is remotely controlled.</p>

**Tip**

- Press **Timer** to enter the timer interface. At this time, the **Timer** key is illuminated. Then, pressing **Timer** again will return to the main interface.
- Press **System** to enter the system utility function interface. If the **Timer** key is not illuminated, pressing **System** again will return to the main interface; if the **Timer** key is illuminated, pressing **System** again will return to the timer interface.
- Press **Memory** to enter the store and recall interface. If the **Timer** key is not illuminated, pressing **Memory** again will return to the main interface; if the **Timer** key is illuminated, pressing **Memory** again will return to the timer interface.

## Power-on Inspection

The DP700 series power supply supports various specifications of AC input power. When the DP700 series is connected with different power sources, the AC selector setting on the rear panel of the instrument is different, as shown in the table below.

Table 1-2 AC Input Power Specification and AC Selector Setting

AC Input Power	AC Selector
100 Vac x (100% ± 10%), 50 Hz to 60 Hz	100 Vac
120 Vac x (100% ± 10%), 50 Hz to 60 Hz	120 Vac
220 Vac x (100% ± 10%), 50 Hz to 60 Hz	220 Vac
240 Vac x (100% ± 10%) (max: 253 Vac), 50 Hz to 60 Hz	240 Vac

Please strictly follow the steps below to connect the instrument to the power supply, and perform the power-on inspection and output inspection.

### 1. Check the input power

Ensure that the AC power to be connected to the instrument conforms to the AC input power requirement specified in Table 1-2.

### 2. Check the AC selector

Ensure that the AC selector setting on the rear panel of the instrument matches the actual AC input power (refer to Table 1-2).

### 3. Check the fuse

When leaving the factory, the instrument has installed a fuse that conforms to the standard of the destination country. When the AC Selector is set to 100 Vac or 120 Vac, Fuse T5A is used; when the AC Selector is set to 220 Vac or 240 Vac, Fuse T2.5A is used.

### 4. Connect the AC power

Plug the specified power cord available in the accessories into the AC power supply connector of the instrument, and then connect the instrument to the properly grounded AC power.



#### **WARNING**

To avoid electric shock, ensure that the instrument is correctly grounded.

### 5. Power on the instrument

Press the Power key , and then the instrument is launched and begins to perform the self-inspection. If the instrument passes the self-inspection, the welcome interface is displayed; otherwise, self-inspection failure information about corresponding items (including the analog board, OVP, OCP, fan, and temperature) will be displayed.

**Tip**



After powering off the instrument, please wait for at least 2 s to power it on again.

**6. Perform the output check**

Perform the output check to ensure that the power supply can output the rated values and properly respond to the operations on the front panel.

**Note:** Before checking the current output, you should complete the check for the voltage output first.

**Check the voltage output:** verify the basic voltage functions without a load.

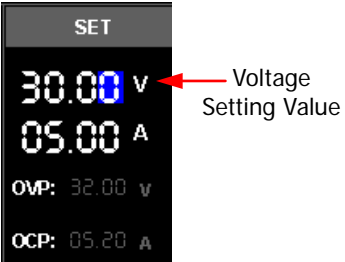
- (1) Press  to turn off the instrument.
- (2) Ensure that no load is connected to the channel output terminals on the front panel. Then, press  to power on the instrument, and check whether the voltage between the positive terminal (+) and negative terminal (-) of the channel output is 0 V.
- (3) Press **On/Off** to turn on the channel output. At this time, the actual output status (actual output voltage (V), actual output current (A), and actual output power (W)) on the left section of the interface is highlighted, and the actual output mode (CV) is displayed.
 
- (4) Set the output voltage to 0 V (For setting methods, refer to the descriptions of the help information at the bottom of the interface or descriptions in "**Parameter Setting Method**".), and check whether the actual output voltage displayed on the left section of the interface is approximately 0 V, the actual output current approximately 0 A. Set the output voltage to 30 V (max. rating value), and check whether the actual output voltage is approximately 30 V, the actual output current approximately 0 A.
 
- (5) Press **On/Off** to turn off the channel output.

**Check the current output:** verify the basic current functions with a short across the power supply's output.

- (1) Connect a short across the positive terminal (+) and negative terminal (-) of the channel output with an insulated test lead (18 AWG), and then press **On/Off** to turn on the channel output. At this time, the actual output status (actual output voltage (V), actual output current (A), and actual output power (W)) on the left section of the interface is highlighted, and the actual output mode is displayed. (Note that the actual output mode is determined by the resistance of the test lead.)
- (2) Set the output voltage to 2 V (For setting methods, refer to the descriptions of the help information displayed at the bottom of the interface or refer to the descriptions in "**Parameter Setting Method**") and ensure the output mode to be CC.

- (3) Set the output current to 0 A (For setting methods, refer to the descriptions of the help information at the bottom of the interface or descriptions in "**Parameter Setting Method**".), and check whether the actual output current displayed on the left section of the interface is approximately 0 A, the actual output voltage approximately 0 V. Set the output current to 5 A (max. rating value), and check whether the actual output current is approximately 5 A (the actual output voltage indicates the voltage drop arising from the test lead.)

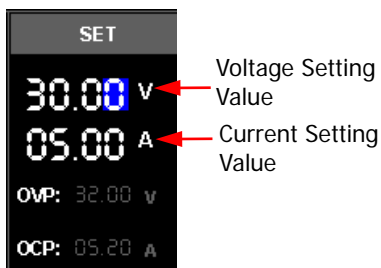

- (4) Press **On/Off** to turn off the channel output.



## Fuse Replacement

The fuse specification is related to the actual input voltage, as shown in the table below. You can also refer to the "Fuse Rating" on the rear panel of the instrument.

Table 1-3 Fuse Rating

Input Voltage	Fuse
100 Vac/120 Vac	T5A 250Vac
220 Vac/240 Vac	T2.5A 250Vac

When leaving the factory, the instrument has installed a fuse that conforms to the standard of the destination country. If the fuse is required to be replaced, select a fuse that matches the actual input voltage and perform the following steps.

1. Turn off the instrument and remove the power cord.
2. Insert a slotted screwdriver into the slot of the fuse cap and push forward, then rotate 45° in the direction shown on the fuse cap and take the fuse cap out.
3. Replace the fuse according to the fuse rating (refer to the "Fuse Rating" on the rear panel of the instrument or Table 1-3).
4. Insert the fuse cap into the slot (pay attention to the direction) and push forward, then rotate 45° in the opposite direction to re-insert the fuse cap.

FUSE RATING	
100V	T5A
120V	250Vac
220V	T2.5A
240V	250Vac

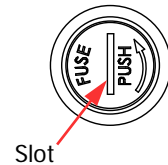

### WARNING

To avoid personal injuries, cut off the power supply before replacing the fuse; to avoid electric shock or fire, before connecting to the AC power, select the voltage specification that matches the actual input voltage and replace a proper fuse that conforms to the voltage specification.

## Built-in Help Information

The help information of the currently displayed interface is displayed in real time at the bottom of the interface, including interface description, how to select the parameter, how to set the parameter, etc. Such information allows you to know the instrument status and provides operation guidance for you.

## Parameter Setting Method

Most parameters can be set through the front panel operations. The common setting methods are listed below. The setting method for certain parameters is different from the methods below, refer to the relevant chapters of this manual for the further explanation.

### Method 1 (Num Key):

1. Press the Up/Down arrow key to switch the parameter focus, such as the voltage setting value, the number of output groups for timer, etc.
2. Enter a value by using the num key.  
While entering a value, press  to delete the unwanted character if necessary.
3. When setting the voltage, press the Up arrow key or **OK** to set the voltage unit to V; press the Down arrow key to set the voltage unit to mV.  
When setting the current, press the Left arrow key to set the current unit to mA; press the Right arrow key or **OK** to set the current unit to A.  
When setting other parameters, press **OK** to confirm it.

### Method 2 (Knob):

1. Press the Up/Down arrow key to switch the parameter focus, such as the voltage setting value, the number of output groups for timer, etc.
2. Press the Left/Right arrow key to move the cursor to a desired position.
3. Rotate the knob to modify the value.

#### Tip

The help information of the currently displayed interface is displayed in real time at the bottom of the interface. You can also refer to the help information to set or modify the parameters.

## Chapter 2 Front Panel Operations

Contents in this chapter:

- Constant Voltage Output
- Constant Current Output
- Power Supply in Series and Parallel Connection
- Timer
- Trigger
- Store and Recall
- System Utility Function
- Remote Locking

## Constant Voltage Output

The DP700 series power supply can work in the constant voltage (CV) or constant current (CC) mode<sup>[1]</sup>. In the CV mode, the output voltage equals to the voltage setting value, and the output current is determined by the load; whereas in the CC mode, the output current equals to the current setting value, and the output voltage is determined by the load. This section introduces the operation method for CV output.

### Operation Methods:

#### 1. Connect the load with the channel output terminals

Turn off the instrument. Connect the load with the channel output terminals on the front panel.



#### CAUTION

While making a connection, the positive polarity of the load should be connected to the (+) terminal of the channel output, and the negative polarity of the load to the (-) terminal of the channel output. A misconnection with the terminals may cause damage to the instrument and the devices connected to it.

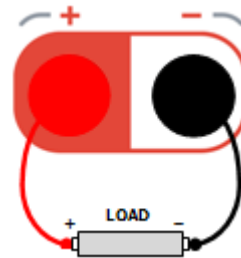

#### 2. Turn on the instrument

Press  to turn on the instrument.

#### 3. Set parameters for the channel output

##### Set the output voltage

(1) In the main interface, press the Up/Down arrow key to switch the parameter focus to "Voltage Setting Value".

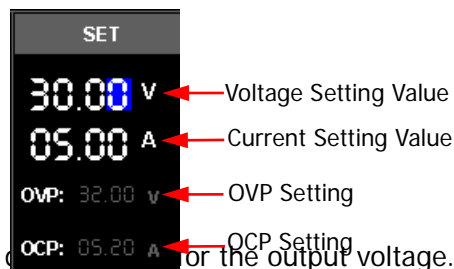

(2) Use the num key or the knob to set a value for the output voltage.

**Note<sup>[1]</sup>:** If the power supply should go into a mode of operation that is neither CV nor CC, the power supply is unregulated (the channel output mode displayed as UR). In this mode, the output is not predictable. The unregulated condition may be caused by the fact that the AC line voltage is below the specifications. This condition may occur temporarily. For example, when the output voltage is programmed for a large change, the output capacitor or a large capacitive load will charge up until the current reaches the setting value. During the ramp-up of the output voltage, the power supply will be in the unregulated mode. During the transition from CV to CC (e.g. transition caused by a short circuit on the output), the unregulated condition may occur temporarily.

For setting methods, refer to the descriptions of the help information displayed at the bottom of the corresponding interface or refer to the descriptions in "**Parameter Setting Method**".

#### **Set the output current**

- (1) In the main interface, press the Up/Down arrow key to switch the parameter focus to "Current Setting Value".
- (2) Use the num key or the knob to set a desired value for the output current. For setting methods, refer to the descriptions of the help information displayed at the bottom of the corresponding interface or refer to the descriptions in "**Parameter Setting Method**".

#### **Set the overvoltage protection**

- (1) In the main interface, press the Up/Down arrow key to switch the parameter focus to "OVP Setting".
- (2) Press **OK** to enable/disable the overvoltage protection function. When "OVP" is indicated in yellow, it indicates that the overvoltage protection function is enabled; when "OVP" is indicated in white, it indicates that the overvoltage protection function is disabled.
- (3) Use the num key or the knob to set a desired value for the overvoltage protection. For setting methods, refer to the descriptions of the help information displayed at the bottom of the corresponding interface or refer to the descriptions in "**Parameter Setting Method**".

#### **Set the overcurrent protection**

- (1) In the main interface, press the Up/Down arrow key to switch the parameter focus to "OCP Setting".
- (2) Press **OK** to enable/disable the overcurrent protection function. When "OCP" is indicated in yellow, it indicates that the overcurrent protection function is enabled; when "OCP" is indicated in white, it indicates that the overcurrent protection function is disabled.
- (3) Use the num key or the knob to set a desired value for the overcurrent protection. For setting methods, refer to the descriptions of the help information displayed at the bottom of the corresponding interface or refer to the descriptions in "**Parameter Setting Method**".

#### **4. Turn on the channel output**

Press **On/Off** to turn on the channel output. Then, the actual output voltage (V), the actual output current (A), and the actual output power (W) are highlighted; the actual output mode (CV) is displayed.

If the CC mode is displayed, please increase the current setting value appropriately.

**WARNING**

To avoid electric shock, ensure that the load is connected to the channel output terminals properly before you turn on the channel output.

**CAUTION**

When the fan works abnormally, the channel output is disabled. Then, a message is displayed, "Fan abnormality, output disabled."

**Tip**

In the CV mode, when the current of the load equals to the current setting value, the power supply will automatically switch to the CC mode. At this time, the output current equals to the current setting value, and the output voltage decreases in proportions.

## Constant Current Output

In the constant current (CC) mode, the output current equals to the current setting value, and the output voltage is determined by the load. This section introduces the operation method for CC output.

### Operation Methods:

#### 1. Connect the load with the channel output terminals

Turn off the instrument. Connect the load with the channel output terminals on the front panel.



#### CAUTION

While making a connection, the positive polarity of the load should be connected to the (+) terminal of the channel output, and the negative polarity of the load to the (-) terminal of the channel output. A misconnection with the terminals may cause damage to the instrument and the devices connected to it.

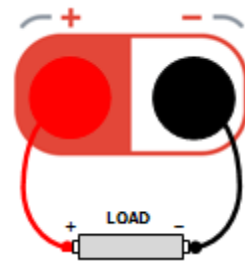

#### 2. Turn on the instrument

Press  to turn on the instrument.

#### 3. Set parameters for the channel output

##### Set the output voltage

- (1) In the main interface, press the Up/Down arrow key to switch the parameter focus to "Voltage Setting Value".
- (2) Use the num key or the knob to set a desired value for the output voltage. For setting methods, refer to the descriptions of the help information displayed at the bottom of the corresponding interface or refer to the descriptions in "**Parameter Setting Method**".

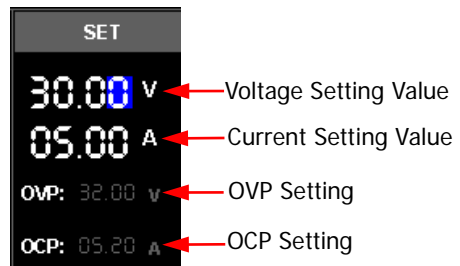

##### Set the output current

- (1) In the main interface, press the Up/Down arrow key to switch the parameter focus to "Current Setting Value".
- (2) Use the num key or the knob to set a desired value for the output current. For setting methods, refer to the descriptions of the help information

displayed at the bottom of the corresponding interface or refer to the descriptions in "**Parameter Setting Method**".

### Set the overvoltage protection

- (1) In the main interface, press the Up/Down arrow key to switch the parameter focus to "OVP Setting".
- (2) Press **OK** to enable/disable the overvoltage protection function. When "OVP" is indicated in yellow, it indicates that the overvoltage protection function is enabled; when "OVP" is indicated in white, it indicates that the overvoltage protection function is disabled.
- (3) Use the num key or the knob to set a desired value for the overvoltage protection. For setting methods, refer to the descriptions of the help information displayed at the bottom of the corresponding interface or refer to the descriptions in "**Parameter Setting Method**".

### Set the overcurrent protection

- (1) In the main interface, press the Up/Down arrow key to switch the parameter focus to "OCP Setting".
- (2) Press **OK** to enable/disable the overcurrent protection function. When "OCP" is indicated in yellow, it indicates that the overcurrent protection function is enabled; when "OCP" is indicated in white, it indicates that the overcurrent protection function is disabled.
- (3) Use the num key or the knob to set a desired value for the overcurrent protection. For setting methods, refer to the descriptions of the help information displayed at the bottom of the corresponding interface or refer to the descriptions in "**Parameter Setting Method**".

## 4. Turn on the channel output

Press **On/Off** to turn on the channel output. Then, the actual output voltage (V), the actual output current (A), and the actual output power (W) are highlighted; the actual output mode (CC) is displayed.

If the CV mode is displayed, please increase the voltage setting value appropriately.



---

### WARNING

To avoid electric shock, ensure that the load is connected to the channel output terminals properly before you turn on the channel output.

---



---

### CAUTION

When the fan works abnormally, the channel output is disabled. Then, a message is displayed, "Fan abnormality, output disabled."

---



**Tip**

In the CC mode, when the voltage of the load equals to the voltage setting value, the power supply will automatically switch to the CV mode. At this time, the output voltage equals to the voltage setting value, and the output current decreases in proportions.

## Power Supply in Series and Parallel Connection

The DP700 series power supply supports series and parallel connections. Connecting two or multiple power supplies in series/in parallel can provide higher voltage/current.

In series and parallel connections, the parameter settings must comply with the safety requirements.

### Power Supply in Series Connection

The output voltage of the power supplies that are connected in series is the sum of the output voltages of all the channels. Take the series connection of two channels as an example. The connection method is as shown in the figure below.

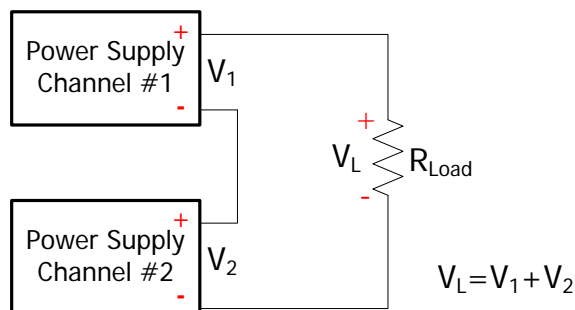

#### Operation Procedures:

1. Connect the load and the channel output terminals as shown in the figure above. Pay attention to the polarity when making connections (the positive and negative polarity of each channel is connected in alternating sequence).
2. Turn on the instrument, and then refer to "**Constant Voltage Output**" to set the channel output parameters that comply with the safety requirements.
  - (1) Set a proper output voltage for each channel.  
**Note:** Ensure that all the channels in series connection work in the CV mode.
  - (2) Set the same output current values for all the channels.  
**Note:** The current setting values for all the channels must be the same.
  - (3) Set the same overcurrent protection values for all the channels and enable the overcurrent protection function for each channel.  
**Note:** The overcurrent protection values for all the channels must be the same.
3. Enable the output of each channel.

At this time, the voltage of the load is the sum of the output voltages of the two channels ( $V_L = V_1 + V_2$ ).

### Tip

1. When connecting the power supply in series, the total voltage in series connection cannot exceed 240 V.
2. You can enable the external trigger function to realize the synchronous output for multiple power supplies. For details, refer to "**Synchronous Output**".

## Power Supply in Parallel Connection

The output current of the power supplies that are connected in parallel is the sum of the output currents of all the channels. Take the parallel connection of two channels as an example. The connection method is as shown in the figure below.

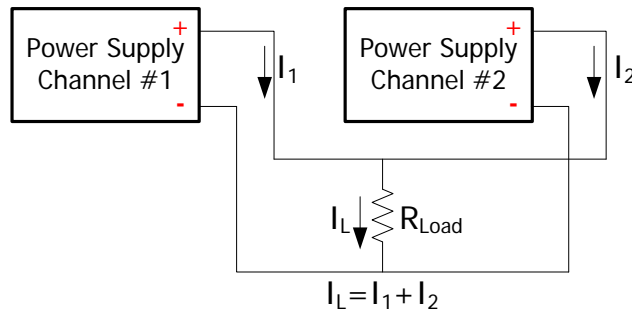

### Operation Procedures:

1. Connect the load and the channel output terminals as shown in the figure above. Pay attention to the polarity when making connections. (The channels follow the "positive-positive" and "negative-negative" connection rule.)
2. Turn on the instrument, and then set proper output parameters for each channel by referring to "**Constant Voltage Output**".  
**Note:** All channels can work either in the CV or CC mode, which depends on the actual situation of the load.
3. Enable the output of each channel.  
At this time, the current of the load is the sum of the output currents of the two channels ( $I_L = I_1 + I_2$ ).

### Tip

You can enable the external trigger function to realize the synchronous output for multiple power supplies. For details, refer to "**Synchronous Output**".

# Timer

DP700 series power supply provides the timer function. When the timing output is enabled, the instrument will configure the output voltages and currents based on the preset timer parameters. The edited timer parameters are allowed to be saved to the internal non-volatile memory (NVM), and can be recalled if necessary.

Timer is an optional function. If you want to use the timer function, order the option based on the Order No. available in "**Appendix A: Order Information**", and then install the option by referring to "**Option Configuration**".

Press **Timer** to enter the timer interface (at this time, the **Timer** key is illuminated), as shown in the figure below.

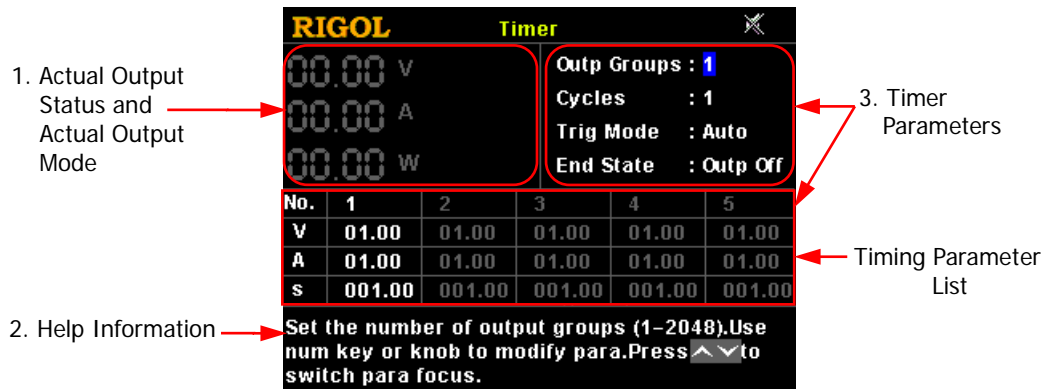

Figure 2-1 Timer Interface

Table 2-1 Timer Interface Description

No.	Name	Description
1	Actual Output Status and Actual Output Mode	Displays the actual output status of the channel in real time, including the actual output voltage (V), the actual output current (A), and the actual output power (W). The actual output mode can be CV, CC, or UR.
2	Help Information	Displays the help information of the current interface, including the interface description, operation method, etc.
3	Timer Parameters	Includes the number of output groups, the number of cycles, trigger mode, end state, and timing parameter list. The timing parameter list consists of the group ID, the output voltage (V), the output current (A), and duration time (s).

If you want to use the timer function, set the timer parameters first and then enable the timing output.

## Set Timer Parameters

### Operation Procedures:

#### 1. Enter the timer interface

Press **Timer** to enter the timer interface (at this time, the **Timer** key is illuminated).

**Note:** When you enter the timer interface, the channel output is automatically disabled.

#### 2. Set the number of output groups

"Outp Groups" indicates the number of groups of the preset voltage and current values that the instrument outputs in each cycle. Its range is from 1 to 2048.

- (1) Press the Up/Down arrow key to switch the parameter focus to "Outp Groups".
- (2) Use the num key or the knob to set a desired value for "Outp Groups". For setting methods, refer to the descriptions of the help information displayed at the bottom of the interface or refer to the descriptions in "**Parameter Setting Method**".

#### 3. Set the number of cycles

"Cycles" refers to the number of cycle times that the instrument performs timing output according to the preset voltage and current values. Its range is from 1 to 99999. When the value is 1, you can use the knob to decrease the number further, and then it will be switched to the infinite mode.

- (1) Press the Up/Down arrow key to switch the parameter focus to "Cycles".
- (2) Use the num key or the knob to set a desired value for "Cycles". For setting methods, refer to the descriptions of the help information displayed at the bottom of the interface or refer to the descriptions in "**Parameter Setting Method**".

#### Tip

- Total Number of Output Groups For the Timer = Outp Groups x Cycles
- After the instrument has completed outputting operation for a specified number of times (total number of output groups), the timing output will be terminated. At this time, the state of the instrument is determined by the "**end state**" that you have set. Note: in the Infinite mode, "End State" is invalid.

#### 4. Select the trigger mode

"Trig Mode" refers to the timing output mode of the instrument.

Auto: when the timing output is enabled, the instrument automatically outputs based on the parameter configuration of the timer.

Single: when the timing output is enabled, one single press on **OK** enables a single output based on a group of timing parameters, until the instrument has

completed outputting operation for a specified number of times (total number of output groups).

- (1) Press the Up/Down arrow key to switch the parameter focus to "Trig Mode".
- (2) Press the Left/Right arrow key or use the knob to select the desired trigger mode.

5. Select the end state

"End State" refers to the state of the instrument after it has completed outputting groups of voltage and current values for a specified number of times (the total number of output groups) when the number of cycles is a finite value. Outp Off: indicates that the output will be turned off automatically after the output is completed.

Last: keeps the output state (voltage/current) of the last group after the output is completed.

- (1) Press the Up/Down arrow key to switch the parameter focus to "End State".
- (2) Press the Left/Right arrow key or use the knob to select the desired end state.

**Tip**  
When "Cycles" is set to "Infinite", "End State" is invalid.

6. Edit the timing parameter list

The timing parameters are used to control the output of the instrument. The parameters consist of the group ID, the output voltage, the output current, and duration time. You can select a group ID first and then set the timing parameters for the group.

One Group of Timing Parameters

	No.	1	2	3	4	5
Group ID						
Output Voltage	V	02.00	01.00	02.00	01.00	01.00
Output Current	A	01.00	00.05	02.00	01.00	01.00
Duration Time	S	001.00	002.00	002.50	001.00	001.00

(1) Select a group ID

If the parameter focus is currently on the "Group ID" line, press the Left/Right arrow key or use the knob to select the desired group ID directly, or use the num key to select the desired group ID. For setting methods, refer to the descriptions of the help information displayed at the bottom of the interface or refer to the descriptions in "Parameter Setting Method".

If the parameter focus is currently not on the "Group ID" line, first press the Up/Down arrow key to switch the parameter focus to the "Group ID" line, and then select the desired group ID.

(2) Set the output voltage

- Press the Up/Down arrow key to switch the parameter focus to the "Output Voltage" line.
- Use the num key or the knob to set a desired value for the output voltage (the default unit is V). For setting methods, refer to the descriptions of the help information displayed at the bottom of the interface or refer to the descriptions in "**Parameter Setting Method**".

**Note:** when the current parameter focus is on the "Output Voltage" line, press the Left or Right arrow key continuously to switch the parameter focus to the "Output Voltage" of the neighboring group.

(3) Set the output current

- Press the Up/Down arrow key to switch the parameter focus to the "Output Current" line.
- Use the num key or the knob to set a desired value for the output current (the default unit is A). For the setting method, refer to the description of the help information displayed at the bottom of the interface or refer to the description in "**Parameter Setting Method**".

**Note:** when the current parameter focus is on the "Output Current" line, press the Left or Right arrow key continuously to switch the parameter focus to the "Output Current" of the neighboring group.

(4) Set the duration time

- Press the Up/Down arrow key to switch the parameter focus to the "Duration Time" line.
- Use the num key or the knob to set a desired value for the duration time (the default unit is s). For setting methods, refer to the descriptions of the help information displayed at the bottom of the interface or refer to the descriptions in "**Parameter Setting Method**".

**Note:** when the current parameter focus is on the "Duration Time" line, press the Left or Right arrow key continuously to switch the parameter focus to the "Duration Time" of the neighboring group.

### Store and Recall Timer Files

The internal NVM of the DP700 series power supply provides two storage locations for timer files (Timer1 and Timer2). You can save the edited timing parameters to the internal memory, or recall the stored timer files to set the timing parameters.

1. Store the timer files  
Press **Memory** to enter the store and recall interface. To save the timer files, refer to "**Store Files**".
2. Recall the timer files  
Press **Memory** to enter the store and recall interface. To read the timer files, refer to "**Recall Files**". After reading the files, the timing parameters will make changes, but you can still edit the timing parameters based on your needs.

## Enable the Timing Output

Enabling the timing output will modify the channel output values. Therefore, before enabling the timing output, ensure that the changes of the channel output will not affect the devices that are connected to the power supply.

In the timer interface, after setting the parameters for the timer, press **On/Off** and select "YES", then the timing output is executed based on the current setting.

- The timer interface displays the actual output status of the channel in real time, including the actual output voltage, the actual output current, the actual output power, and the output mode.
- In the timing parameter list, the groups that have been output are grayed out; the current output group is indicated in yellow; and the groups that have not been output are indicated in white.
- When "Cycles" is a specified value, after the instrument has completed outputting operation for a specified number of times (total number of output groups), the timing output will be terminated. At this time, the state of the instrument is determined by the "**end state**" that you have set.  
When "Cycles" is set to "Infinite", the instrument makes consecutive outputs based on the current timer parameter settings. At this time, the end state is invalid.

#### Tip

Complete timer parameter settings before enabling the timing output. During the timing output, the timer parameters are not allowed to be modified.



During the timing output:

- Press **On/Off** to disable the timing output. When you press **On/Off** again, the system will start to output from the first group.
- Press **Timer** and select "YES" to close the timer and return to the main interface.

## Trigger

DP700 series power supply provides the trigger function, including trigger input and trigger output. Trigger input indicates that the external trigger input signal controls the on/off status of the channel output. Trigger output indicates that controlling the on/off status of the channel output can enable the instrument to output the specified signal. When multiple power supplies are in serial or parallel connection, enabling the external trigger function can realize the synchronous output for multiple power supplies.

Pin 8 of the RS232 interface on the rear panel is used for trigger input, and Pin 7 for trigger output.

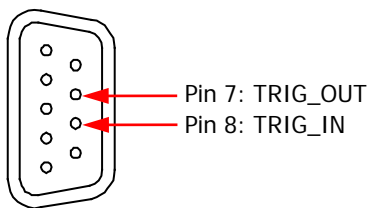

Trigger is an optional function. If you want to use the trigger function, order the option based on the Order No. available in "**Appendix A: Order Information**", and then install the option by referring to "**Option Configuration**".

## Trigger Input

Pin 8 of the RS232 interface on the rear panel is used to receive the external trigger input signal. When it receives a high level signal ( $\geq 2.1\text{ V}$ ,  $10\text{ mA}$ ), the channel output will be turned on; when it receives a low level signal ( $\leq 0.7\text{ V}$ ,  $10\text{ mA}$ ), the channel output will be turned off.

### Operation Procedures:

1. Turn off the instrument. Connect the external trigger input signal to Pin 8 of the RS232 interface on the rear panel.
2. Connect the load with the channel output terminals on the front panel.
3. Turn on the instrument. Press **System** to enter the system utility interface. By default, the "Setting" tab is selected. Press the Up/Down arrow key to switch the parameter focus to "Trig In", and press the Left/Right arrow key or the knob to enable the trigger input function.

## Trigger Output

Pin 7 of the RS232 interface on the rear panel is used to output the trigger output signal. When the channel output is turned on, the high level signal ( $\geq 2.1$  V, 10 mA) is output from Pin 7; when off, the low level signal ( $\leq 0.7$  V, 10 mA) is output from Pin 7.

### Operation Procedures:

1. Turn off the instrument. Connect Pin 7 of the RS232 interface on the rear panel to the signal receiving/display device.
2. Connect the load with the channel output terminals on the front panel.
3. Turn on the instrument. Press **System** to enter the system utility interface. By default, the "Setting" tab is selected. Press the Up/Down arrow key to switch the parameter focus to "Trig Out", and press the Left/Right arrow key or the knob to enable the trigger output function.

## Synchronous Output

When multiple power supplies are in serial or parallel connection, enabling the external trigger function can realize the synchronous output for multiple power supplies.

DP700 series power supply provides the following synchronous output modes:

### Mode 1:

Take the trigger output signal of one power supply (master device) as the trigger input signal of the other power supplies (slave devices). In this case, you can press **On/Off** on the power supply (master device) to synchronously control the output of all the power supplies. The following example illustrates the operation steps on how to synchronously control the other two power supplies through one power supply.

### Operation Procedures:

1. Connect Pin 7 (trigger output signal) of the RS232 interface on the rear panel of Power Supply 1 to Pin 8 (trigger input signal) of the RS232 interface on the rear panel of Power Supply 2 and 3, as shown in the figure below.

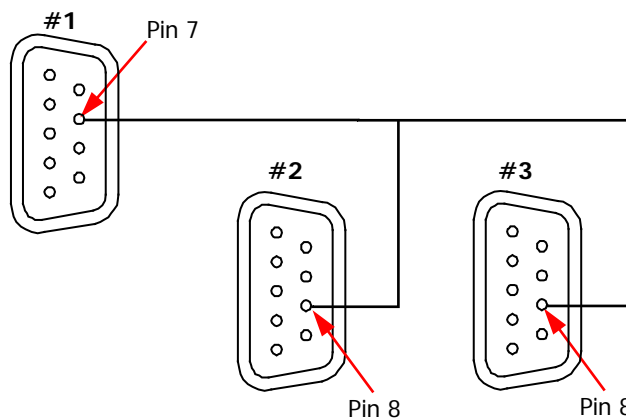

2. Enable the trigger output function of Power Supply 1; and enable the trigger input function of Power Supply 2 and 3.
3. Press **On/Off** on Power Supply 1 to turn on its channel output. At this time,
  - As the trigger output function of Power Supply 1 is enabled, Power Supply 1 will output the trigger output signal (a high level signal,  $\geq 2.1\text{ V}$ , 10 mA) from Pin 7.
  - As the trigger input functions of Power Supply 2 and 3 have been enabled, after Power Supply 2 and 3 receives trigger input signal (i.e. trigger output signals of Power Supply 1), the channel output will be turned on.

Similarly, when you press **On/Off** on Power Supply 1 to turn off its channel output, the channel output of Power Supply 2 and 3 will also be turned off.

Now, the operation is complete. You can press **On/Off** on Power Supply 1 to synchronously control the output of Power Supply 1, 2, and 3.

### Mode 2:

Take the trigger output signal of one power supply as the trigger input signal of its adjacent power supply in sequence. In this case, you can press **On/Off** on the first power supply to synchronously control the output of all the power supplies. The following example illustrates the operation steps on how to synchronously control the other two power supplies through one power supply.

### Operation Procedures:

1. Connect Pin 7 (trigger output signal) of the RS232 interface on the rear panel of Power Supply 1 to Pin 8 (trigger input signal) of the RS232 interface on the rear panel of Power Supply 2, and connect Pin 7 (trigger output signal) of the RS232 interface on the rear panel of Power Supply 2 to Pin 8 (trigger input signal) of the RS232 interface on the rear panel of Power Supply 3, as shown in the figure below.

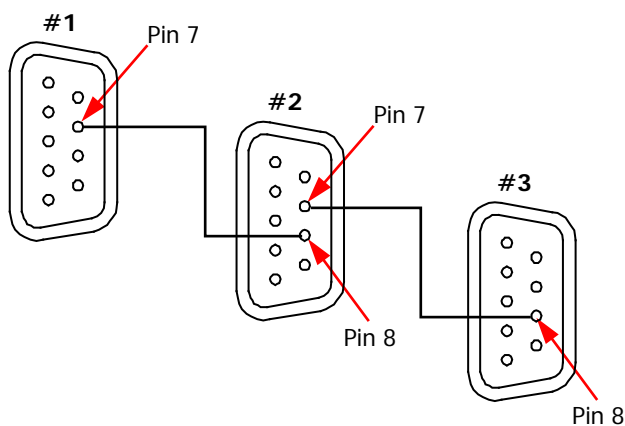

2. Enable the trigger output function of Power Supply 1; enable the trigger input and output functions of Power Supply 2; enable the trigger input function of Power Supply 3.
3. Press **On/Off** on Power Supply 1 to turn on its channel output. At this time,
  - As the trigger output function of Power Supply 1 has been enabled, Power Supply 1 will output the trigger output signal (a high level signal,  $\geq 2.1$  V, 10 mA) from Pin 7.
  - As the trigger input function of Power Supply 2 has been enabled, after Power Supply 2 receives the trigger input signal (i.e. the trigger output signal of Power Supply 1), the channel output will be turned on.
  - As the trigger output function of Power Supply 2 has been enabled, when the channel output of Power Supply 2 is turned on, Power Supply 2 will output the trigger output signal (a high level signal,  $\geq 2.1$  V, 10 mA) from Pin 7.
  - As the trigger input function of Power Supply 3 has been enabled, after Power Supply 3 receives the trigger input signal (i.e. the trigger output signal of Power Supply 2), the channel output will be turned on.

Similarly, when you press **On/Off** on Power Supply 1 to turn off its channel output, the channel output of Power Supply 2 and 3 will also be turned off.

Now, the operation is complete. You can press **On/Off** on Power Supply 1 to synchronously control the output of Power Supply 1, 2, and 3.

## Store and Recall

DP700 series power supply allows you to save the instrument status or timer parameters to the internal NVM, and recall them if necessary. Besides, you can restore the instrument to default settings and clear the saved state files and timer files.

Press **Memory** to enter the store and recall interface, as shown in the figure below.

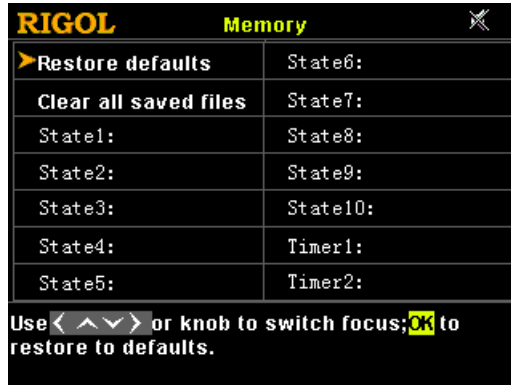

Figure 2-2 Store and Recall Interface

Table 2-2 Store and Recall Interface Description

No.	Name	Description
1	State1 to State10	Indicates the storage location of the state file. The state file is used to store the current state information of the instrument, including but not limited to parameter and system status.
2	Timer1/Timer2	Indicates the storage location of the timer file. The timer file is used to store timer parameters, including the number of output groups, the number of cycles, trigger mode, end state, output voltage, output current, and duration time.
3	Restore default setting	Restores the instrument settings to defaults (refer to Table 2-3).
4	Clear all saved files	Clears all saved state files and timer files in the internal NVM.

## Manage Files

The internal NVM of the DP700 series power supply provides ten storage locations for state files and two for timer files. Therefore, you are allowed to save the current status information of the instrument or its timer parameters to the specified location, and recall the saved files if necessary.

### Store Files

The file name can contain lowercase letters (a-z) and numbers (0-9). The maximum length of the file name is 11 characters.

#### Operation Procedures:

##### 1. Specify a storage location

Press **Memory** to enter the store and recall interface, and then press the Up/Down/Left/Right arrow key or use the knob to switch the parameter focus to a desired storage location for state file (State1 to State10) or a desired storage location for timer file (Timer1 or Timer2).

##### 2. Enter a file name

(1) Press **OK** and then the file management options are displayed at the bottom of the interface. By default, "Save" is selected. (You can also press the Left/Right arrow key or use the knob to select "Save".) Then press **OK** to enter the file name input interface.

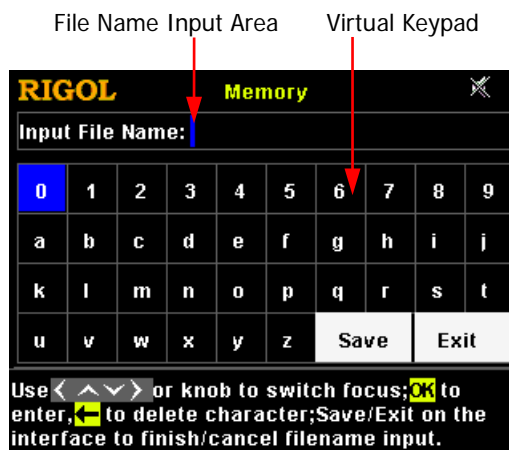



Figure 2-3 File Name Input Interface

(2) In the file name input interface, press the Up/Down/Left/Right arrow key or use the knob to select the desired characters on the virtual keypad, and then press **OK** to enter the characters. The input characters are displayed

in the "File Name Input Area". While entering a name, press  to delete the unwanted character if necessary.

### 3. Save a file

After inputting a file name, select "Save" on the virtual keypad and press **OK** to save the file. After the file is saved, a message will be displayed, prompting you that you have saved the file.

If there is an existing file in the currently selected location, you can determine whether to overwrite the existing file. Press the Left/Right arrow key to select "YES" and press **OK** to overwrite the existing saved file; select "NO" and press **OK** to give up saving the file.

#### Tip

If you want to quit the saving operation, select "Exit" on the virtual keypad to give up saving the file, and then press **OK**.

## Recall Files

You are allowed to recall all saved state files and timer files. After the files have been read, the status information of the instrument or the timer parameters will make changes accordingly.

### Operation Procedures:

1. Press **Memory** to enter the store and recall interface, and then press the Up/Down/Left/Right arrow key or use the knob to switch the parameter focus to the storage location where the file to be recalled can be found.
2. Press **OK** and then press the Left/Right arrow key or use the knob to select "Read" to read the saved file in the selected storage location. After the file reading is complete, a message will be displayed, prompting you that the reading process is complete.  
If no saved file is found in the selected storage location, the "Read" key is grayed out and disabled.

## Delete Files

You are allowed to delete the saved state files and timer files.

### Operation Procedures:

1. Press **Memory** to enter the store and recall interface, and then press the Up/Down/Left/Right arrow key or use the knob to switch the parameter focus to the storage location where files to be recalled can be found.



2. Press **OK** and then press the Left/Right arrow key or use the knob to select "Dele" to delete the saved file in the selected storage location. After deleting the file, a message will be displayed, prompting you that the deleting process is complete.  
If no saved file is found in the selected storage location, the "Dele" key is grayed out and disabled.

**Note:** The locked files are not allowed to be deleted (You can send the SCPI command **:MEMory[:STATE]:LOCK** to lock the files. For details, refer to *DP700 Programming Guide*.)

## Restore Default Settings

Restore the instrument settings to defaults if necessary, as shown in Table 2-3.

### Operation Procedures:

1. Press **Memory** to enter the store and recall interface. By default, "Restore defaults" is selected. You can also press the Up/Down/Left/Right arrow key or use the knob to switch the parameter focus to "Restore defaults".
2. Press **OK** and select "YES" to restore the instrument settings to defaults, as shown in Table 2-3.

Table 2-3 Default Settings

Model	DP711	DP712
<b>Channel Parameter</b>		
Voltage/Current Setting Value	0 V/5 A	0 V/3 A
OVP/OCP Value	32 V/5.3 A	53 V/3.2 A
OVP/OCP On/Off	Off/Off	Off/Off
Output On/Off	Off	Off
<b>System Setting</b>		
Beeper	On	
Screen Saver	Off	
Trigger Input	Off	
Trigger Output	Off	
<b>RS232 Interface Setting</b>		
Baud Rate	9600	
Stop Bit	1	
Data Bit	8	
Parity	None	
<b>Timer</b>		
Number of Output Groups	1	
Number of Cycles	1	
Trigger Mode	Auto	
End State	Output Off	
Timing Parameter	Group ID: 1 Output Voltage: 1 V Output Current: 1 A Duration Time: 1 s	

### Tip

When "**power-on setting**" is set to "Default", it indicates that the instrument will be restored to defaults once the instrument is powered on again.

## Clear All Saved Files

You are allowed to clear all saved state files and timer files in the internal NVM.

### Operation Procedures:

1. Press **Memory** to enter the store and recall interface, and then press the Up/Down/Left/Right arrow key or use the knob to switch the parameter focus to "Clear all saved files".
2. Press **OK** and select "YES" to clear all saved state files and timer files.

## System Utility Function

Press **System** to enter the system utility function interface.

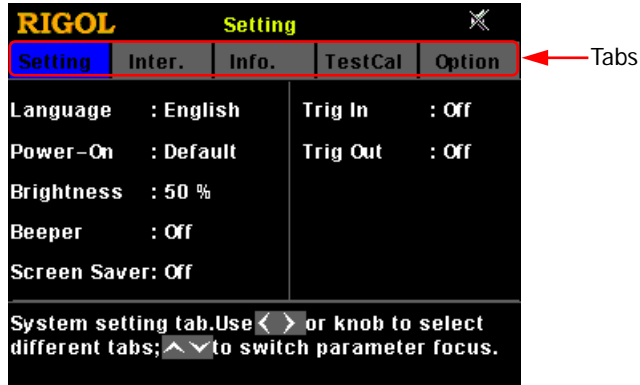

Figure 2-4 System Utility Function Interface

The following table lists names of different tabs and their descriptions. You can view the information contained in each tab and the parameters that can be set.

No.	Name	Description
1	Setting	System setting tab. Select system language; select power-on setting; set screen brightness; turn on/off the beeper and screen saver; turn on/off the trigger input or output.
2	Inter.	RS232 interface tab. Set baud rate and parity; view stop bit and data bit.
3	Info.	System information tab. View device model, serial number, and software version.
4	TestCal	Test and calibration tab. View the test information and auto calibration information; perform manual calibration; and modify the calibration password.
5	Option	System option tab. View the option installation information; install the options.

## System Setting

Press **System** to enter the system utility function interface. By default, the "Setting" tab is selected. You can also press the Left/Right arrow key or use the knob to select the system setting tab.

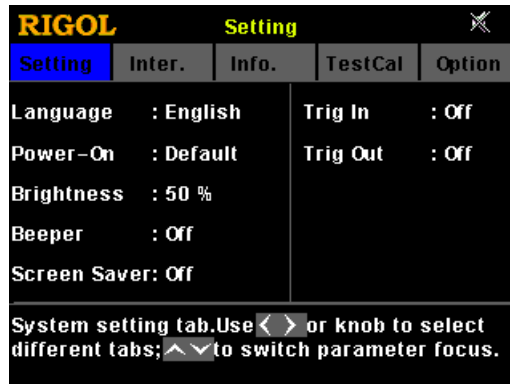

Figure 2-5 System Setting Tab

In the system setting tab, you can select system language, select power-on setting, set screen brightness, turn on/off the beeper and the screen saver, and turn on/off trigger input or output.

### Select the System Language

DP700 series power supply provides the help information, prompt message, and interface display in both Chinese and English version.

In the system setting tab, press the Up/Down arrow key to switch the parameter focus to "Language", and then press the Left/Right arrow key or use the knob to select the desired language: Chinese or English.

### Select Power-on Setting

Select "Default" or "Last" as the power-on setting.

- Default: restores defaults when the instrument is powered on, refer to Table 2-3.
- Last: restores its last state when the instrument is powered on.

In the system setting tab, press the Up/Down arrow key to switch the parameter focus to "Power-on", and then press the Left/Right arrow key or use the knob to select the desired power-on state: Default or Last.

## Set the Screen Brightness

The settable screen brightness ranges from 1% to 100%.

In the system setting tab, press the Up/Down arrow key to switch the parameter focus to "Brightness", and then use the num key or knob to select the desired brightness. For setting method, refer to the descriptions of the help information displayed at the bottom of the interface or refer to the descriptions in "**Parameter Setting Method**".

## Turn On/Off the Beeper

When the beeper is turned on, the  icon is displayed in the status bar. In this case, the beeper sounds when you perform the following operations.

- When you press the keys on the front panel;
- When you rotate the knob;
- When an error occurs in remote operation.

In the system setting tab, press the Up/Down arrow key to switch the parameter focus to "Beeper", and then press the Left/Right arrow key or use the knob to turn on or off the beeper.

## Turn On/Off the Screen Saver

When the screen saver function is enabled, if no operation is performed on the front panel for more than 25 minutes, the instrument automatically enters the screen saver mode; if it persists for another 12.5 minutes, the screen of the instrument stays black.

In the system setting tab, press the Up/Down arrow key to switch the parameter focus to "Screen Saver", and then press the Left/Right arrow key or use the knob to enable or disable the screen saver function.

## Enable the Trigger Function

DP700 series power supply provides the trigger function (optional), including trigger input and trigger output. For details of the function, refer to the descriptions in "**Trigger**". If you want to use the trigger function, order the option based on the Order No. available in "**Appendix A: Order Information**", and then install the option by referring to "**Option Configuration**".

**Trigger Input:**

In the system setting tab, press the Up/Down arrow key to switch the parameter focus to "Trig In", and then press the Left/Right arrow key or use the knob to enable or disable the trigger input function.

**Trigger Output:**

In the system setting tab, press the Up/Down arrow key to switch the parameter focus to "Trig Out", and then press the Left/Right arrow key or use the knob to enable or disable the trigger output function.

**Tip**

If the trigger option is not installed, you can enable neither the trigger input nor the trigger output function.

## RS232 Interface Setting

You can remotely control the DP700 series power supply via the RS232 interface. Use the 9-pin RS232 cable (female-to-female, straight) to connect the RS232 interface to the PC, and set the interface parameters (such as baud rate, parity, etc.) that match the PC. Then, you can remotely control the instrument.

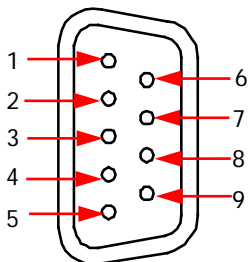

Figure 2-6 RS232 Interface

Table 2-4 Description of Pins of the RS232 Interface

Pin	Name	Description
1	DC Output	Outputs DC: 5 V, 10 mA.
2	TXD (Transmit Data)	Transmits data.
3	RXD (Receive Data)	Receives data.
4	NC	Indicates not connected.
5	SGND	Indicates the signal ground.
6	NC	Indicates not connected.
7*	TRIG-OUT	Outputs the trigger output signal.
8*	TRIG-IN	Receives the trigger input signal.
9	NC	Indicates not connected.

**Note\*:** Pin 7 and Pin 8 of the RS232 interface are not used in remote communication. They are used in the trigger function (optional).

Press **System** to enter the system utility function interface. Press the Left/Right arrow key or use the knob to select the "Inter." tab.

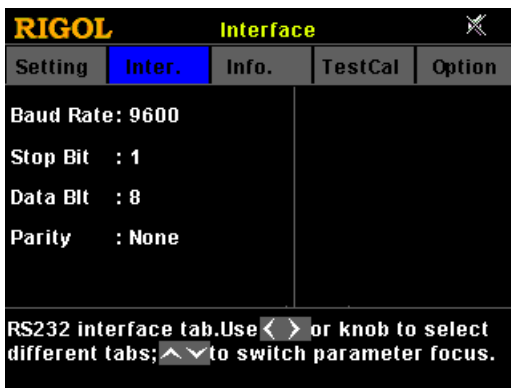

Figure 2-7 RS232 Interface Tab



In the RS232 interface tab, you can set and view the RS232 interface parameters.

1. Baud Rate

The available baud rates include 7200 bps, 9600 bps, 14400 bps, 19200 bps, 38400 bps, 57600 bps, and 115200 bps.

Press the Up/Down arrow key to switch the parameter focus to "Baud Rate", and then press the Left/Right arrow key or use the knob to select the desired baud rate.

2. Stop Bit

Stop bit is 1 and cannot be modified.

3. Data Bit

Data bit is 8 and cannot be modified.

4. Parity

The available parity modes include None, Odd, and Even. Press the Up/Down arrow key to switch the parameter focus to "Parity", and then press the Left/Right arrow key or use the knob to select the desired parity mode.

## System Information

Press **System** to enter the system utility function interface. Press the Left/Right arrow key or use the knob to select the "Info." tab.

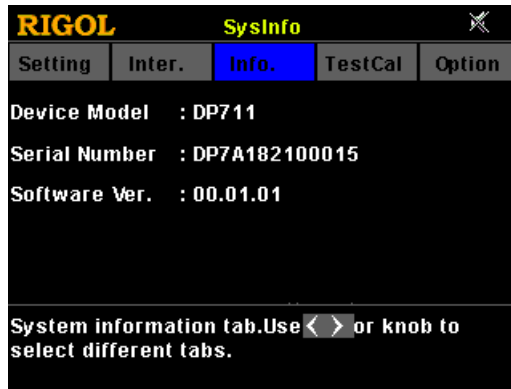

Figure 2-8 System Information Tab

In the system information tab, you can view the system information of the instrument, including the device model, serial number, and software version.

## Test and Calibration

Press **System** to enter the system utility function interface. Press the Left/Right arrow key or use the knob to select the "TestCal" tab.

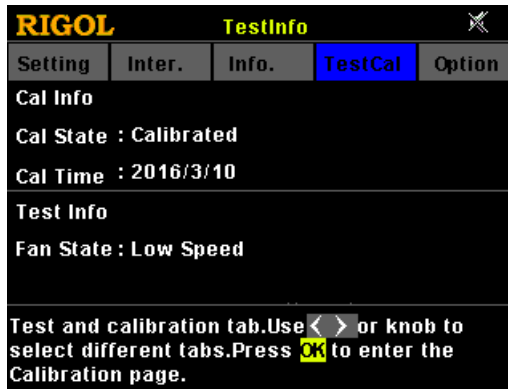

Figure 2-9 Test and Calibration Tab

In the test and calibration tab, you can view the test information and auto calibration information, perform manual calibration, and modify the calibration password.

### View Test&Auto Calibration Information

Test information includes the fan state. The fan state is displayed as Low Speed when the actual output current is less than 2 A; the fan state is displayed as High Speed when the actual output current is equal to or greater than 2 A. Auto calibration information includes the auto calibration status and the last auto calibration time.

### Perform the Manual Calibration

DP700 series power supply supports multiple manual calibration items, including voltage DAC calibration, current DAC calibration, voltage ADC calibration, current ADC calibration, and OVP calibration.

If you want to calibrate the instrument, first enter a calibration password. When leaving the factory, the instrument has been given a default calibration password (123456). In the test and calibration tab, press **OK** to enter a correct calibration password, and then press **OK** to enter the calibration page. Then, you can calibrate the instrument. For the detailed calibration methods, please refer to the calibration guide of this product. After completing the calibration, a message will be displayed, prompting you that calibration is completed.

If needed, you can also follow the steps below or refer to the help information at the

bottom of the instrument interface to modify the password. It is a 6-character password, and can contain numbers (0-9) and dots.

**Password Modification Procedures:**

1. In the calibration page, press the Up/Down arrow key or use the knob to switch the parameter focus to "Passwd".
2. Press **OK** to enter a new password.
3. Press **OK** to enter the new password for confirmation.
4. Press **OK** to complete password modification.

**CAUTION**

We recommend you to calibrate the instrument every other year. Before leaving the factory, the instrument has been calibrated by **RIGOL**.

## Option Configuration

DP700 series power supply provides the following options:

- Trigger: provides the trigger input and output functions.
- Timer: outputs based on the preset voltage and current values.
- High Resolution: improves the resolution of the instrument.

If you need any of these options, order them according to the Order No. available in "**Appendix A: Order Information**", and then install the options according to this section.

Press **System** to enter the system utility function interface. Press the Left/Right arrow key or use the knob to select the "Option" tab.

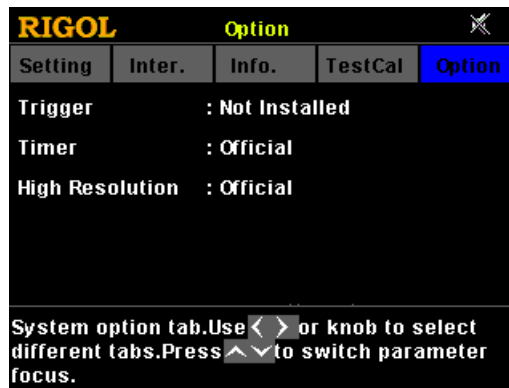

Figure 2-10 System Option Tab

In the system option tab, you can view the installation status of all options (Official, Trial, Not Installed) and install the options.

To install an option, you need an option license (each instrument has a unique license). The option license is a 28-character string, which consists of English letters and numbers. After you purchase an option, you will obtain a key (used for obtaining the option license). Then, you can install the option according to the following steps.

### 1. Obtain an option license

- (1) Log in to the **RIGOL** official website ([www.rigol.com](http://www.rigol.com)), click **SERVICE** → **Software License Register** to enter the "Registered product license code" interface.
- (2) In the interface, enter the correct key, serial number (press **System**, and select the "Info." tab to obtain the serial number of the instrument), and verification code. Then click **Generate** to obtain the option license.

**Note:** The hyphens in the option license should be omitted.

## 2. Install the option

### Method 1: Front Panel Operations

- (1) In the system option tab, press the Up/Down arrow key to switch the parameter focus to the desired option.
- (2) Press **OK** to enter the License Input interface.

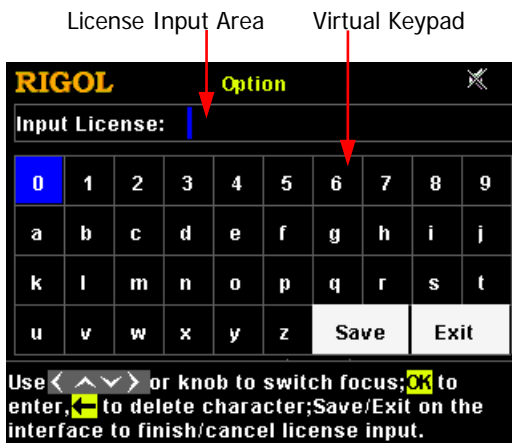

Figure 2-11 License Input Interface

- (3) In the License Input interface, press the Up/Down/Left/Right arrow key or use the knob to select the desired character (the English letter is not case-sensitive) on the virtual keypad, and then press **OK** to enter the character. The entered characters will be displayed in the "License Input Area". While entering the characters, press **⌫** to delete the unwanted character if necessary.  
**Note:** The hyphens in the option license should be omitted.
- (4) After inputting a license, select "Save" on the virtual keypad and press **OK**. If the option has been successfully installed, a prompt message will be displayed; otherwise, a message indicating a failed installation will be displayed.



**Tip**  
If you want to quit the installation operation, select "Exit" on the virtual keypad to give up installing the option, and then press **OK**.

### Method 2: Send SCPI Commands

To set up remote control via the RS232 interface and send the option installation command `:LIC:SET <license>`, refer to "**Remote Control**". Wherein, `<license>` is the option license, and the hyphens in the code should be omitted.  
For example, `:LIC:SET UVF2L3N3XXKYTB73PPRSA4XDMSRT`





## Remote Locking

DP700 series power supply provides the following two remote locking functions to avoid any loss caused by misoperation.

- Front panel locking: locks all keys on the front panel (including the knob, but excluding **On/Off**, , and .
- Key locking: locks the specified keys or all keys on the front panel (including the knob, but excluding .

**Note:** You can lock the front panel or keys by only sending SCPI commands.

## Front Panel Locking

You can send front panel locking command to the DP700 series power supply to lock the front panel. When the front panel is locked, it indicates that all keys (except **On/Off**, , and ) on the front panel are locked.  and  icons will be displayed on the status bar.

The syntax and explanation of the commands for locking the front panel are displayed below:

### Syntax

```
:SYSTEM:LOCK {ON|OFF|1|0}          /*Lock or unlock the front panel*/
:SYSTEM:LOCK?                       /*Query whether the front panel is locked*/
```

### Explanation

The parameters {ON|OFF|1|0} indicate locking or unlocking the front panel. When the parameter value is ON|1, it indicates locking the front panel; when the parameter value is OFF|0, it indicates unlocking the front panel.

#### Brief Descriptions of Commands

- Braces { } and vertical bar | are not part of the command, and they are not sent with the commands, but taken as delimiters to better describe the parameters in the command. The contents enclosed in the braces can contain multiple parameter options; and the vertical bar is used to separate multiple parameter options. When sending the command, you must select one of the parameters.
- The letters in the commands are case-insensitive. The commands can be input in uppercase letters or in lowercase letters. For abbreviations, you must enter all the uppercase letters that exist in the command syntax. For example, :SYSTEM:LOCK ON can be abbreviated as :SYST:LOCK ON.
- The contents in /\*...\*/ are explanations for the command.

For details about the SCPI commands, refer to *DP700 Programming Guide*.

The SCPI commands can be sent to the DP700 series power supply by user-defined programming or PC software. For details, refer to the descriptions in "**Remote Control**".

## Key Locking

You can send key locking command to the DP700 series power supply to lock the keys. You are allowed to lock the specified keys or all keys on the front panel (including the knob, but excluding ). The keys locked cannot be used.

The syntax and explanation of the commands for locking the keys are displayed below:

### Syntax

```
:SYSTem:KLOCK <key>,{ON|OFF|1|0} /*Lock or unlock the specified key*/
:SYSTem:KLOCK? <key> /*Query whether the specified key is locked*/
```

### Explanation

- The parameter <key> indicates a specified key, and its range is as follows:
 

SYSTEM MEMORY TIMER	/*Function keys*/
OUTPUT	/*Output on/off key*/
NUM0 NUM1 NUM2 NUM3 NUM4 NUM5	/*Num keys*/
NUM6 NUM7 NUM8 NUM9 DOT	
BACK	/*Return key*/
KNOB	/*Knob*/
LEFT RIGHT UP DOWN	/*Arrow keys*/
OK	/*Confirmation key*/
ALL	/*All keys on the front panel (excluding  ) and the knob*/
- The parameters {ON|OFF|1|0} indicate locking or unlocking the keys. When the parameter value is ON|1, it indicates locking the keys; when the parameter value is OFF|0, it indicates unlocking the keys.



**Brief Descriptions of Commands**

- The angle-bracket < >, brace { }, and vertical bar | are not part of the command, and they are not sent with the commands, but taken as delimiters to better describe the parameters in the command. When sending the command, the parameter enclosed in the angle-bracket must contain an effective value. The contents enclosed in the braces can contain multiple parameter options; and the vertical bar is used to separate multiple parameter options. When sending the command, you must select one of the parameters.
- The letters in the commands are case-insensitive. The commands can be input in uppercase letters or in lowercase letters. For abbreviations, you must enter all the uppercase letters that exist in the command syntax. For example, :SYSTem:KLOCK? MEMORY can be abbreviated as :SYST:KLOC? MEMORY.
- The contents in /\*...\*/ are explanations for the command.

For details about the SCPI commands, refer to *DP700 Programming Guide*.

The SCPI commands can be sent to the DP700 series power supply by user-defined programming or PC software. For details, refer to the descriptions in "**Remote Control**".



## Chapter 3 Remote Control

You can remotely control the DP700 series power supply in the two following ways.

- **User-defined programming**

Users can program and control the instrument by using the SCPI (Standard Commands for Programmable Instruments) commands. For details about the SCPI commands and programming, refer to *DP700 Programming Guide*.

**Operation Procedures:**

- (1) Set up communication between the instrument and PC.
- (2) Send commands by programming in LabVIEW, MATLAB, etc.

- **Use the PC software**

Users can use the PC software to send commands to control the instrument remotely. **RIGOL** Ultra Sigma is recommended. You can log in to **RIGOL** official website ([www.rigol.com](http://www.rigol.com)) to download the software.

**Operation Procedures:**

- (1) Set up communication between the instrument and PC.
- (2) Run Ultra Sigma and search for the instrument resource.
- (3) Open the remote command control panel to send commands.

DP700 series power supply can communicate with the PC via the RS232 interface. This chapter will illustrate how to use the Ultra Sigma software to remotely control the power supply via the RS232 interface.

### 1. Connect the power supply to the PC

Use the 9-pin RS232 cable (female-to-female, straight) to connect the power supply to the PC through the RS232 interface on the rear panel.

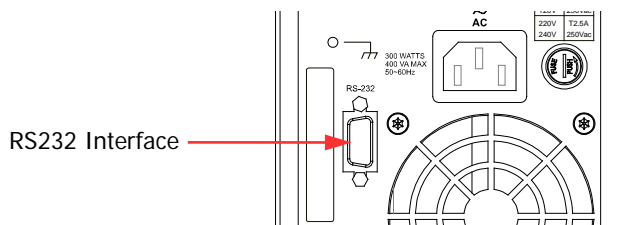

### 2. Set the parameters for the RS232 interface

Press **System**, and then select the "Inter." tab. Set the parameters (baud rate and parity) for the RS232 interface based on the setting descriptions in "**RS232 Interface Setting**".

### 3. Add the device resource

Start Ultra Sigma, and then click "RS232". A window is displayed as shown in

Figure (a).

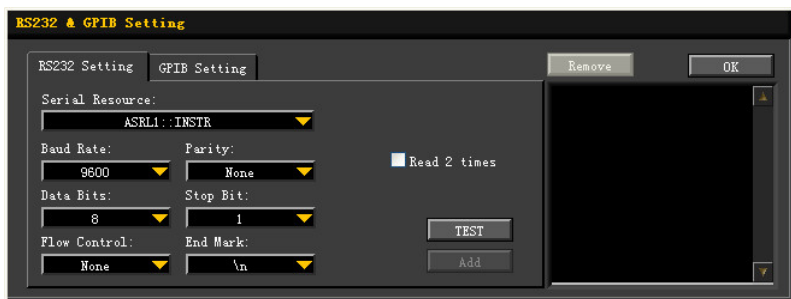

(a)

As shown in Figure (a), in the "RS232 Setting" tab, set Baud Rate, Parity, Data Bits, and Stop Bit that match the current parameters of the RS232 interface of the instrument (**Note:** You must select "None" under the "Flow Control" option, and select "\n" under the "End Mark" option). After completing the settings, click "Test". If the test succeeds, a dialog box, as shown in Figure (b), is displayed.

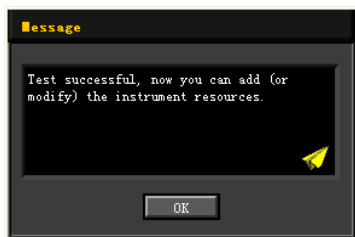

(b)

**Note:** If the test fails, check whether the instrument can communicate with the PC via the RS232 cable normally, and whether the current RS232 settings in Ultra Sigma match those of the instrument.

In the dialog box shown in Figure (b), click "OK". Then the "Add" button in the "RS232 Setting" tab in Figure (a) will be enabled. Click "Add", and then the currently selected instrument resource will be displayed on the right section of the window, as shown in Figure (c). Then, click "OK" to add the instrument resource.



(c)

The added RS232 instrument resource will be displayed under the "RIGOL Online Resource" directory, as shown in the figure below.



#### 4. Control the instrument remotely

Right-click the resource name "DP711 (ASRL1::INSTR)", and select "SCPI Panel Control" to open the remote command control panel. Then you can send commands and read data through the panel.

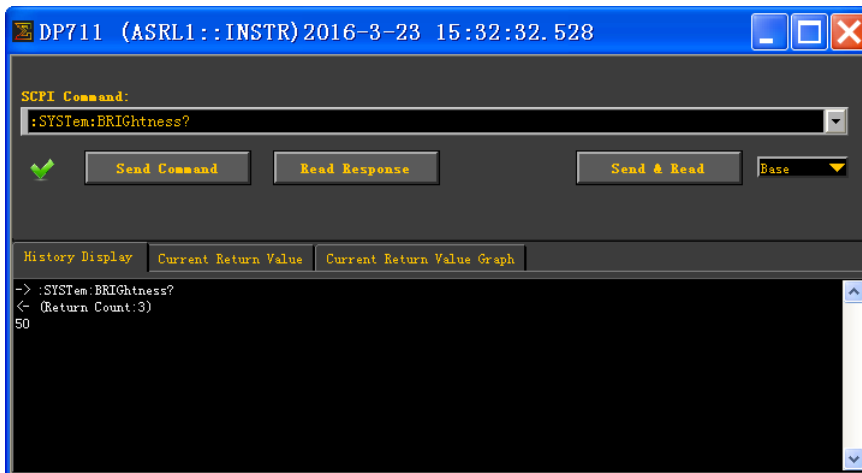



## Chapter 4 Troubleshooting

**WARNING**

Do not disassemble the instrument by yourself. Otherwise, you might be exposed to the danger of electric shock. Only **RIGOL** authorized personnel are allowed to repair, make adjustments, or replace the components of the instrument.

**WARNING**

Only the exclusive power cord designed for the instrument can be used. For replacement of the power cord, please contact **RIGOL**.

This chapter lists the potential problems or failure, as well as the solutions in using the instrument. If the following problems occur, locate and resolve the problems according to the following steps. If the problems still persist, contact **RIGOL** and provide your instrument information to us. (For instrument information, press **System**, and then select the "Info." tab.)

**1. The instrument cannot be powered on.**

- (1) Check whether the power cord is damaged or correctly connected.
- (2) Check whether you have pressed down the Power key .
- (3) Plug out the power cord, and check whether the AC selector is in the proper position, whether the fuse conforms to the fuse rating, and whether the fuse is intact. For fuse replacement, refer to "**Fuse Replacement**".
- (4) If the problem still persists, contact **RIGOL**.

**2. The constant voltage output is abnormal.**

- (1) Check whether the max output power meets the load requirement.
- (2) Check whether there is a short across the cable that connects the load and the power supply, and check whether the connection is in good condition.
- (3) Check whether there is a problem with the load.
- (4) Check whether the current setting value is proper. If the value is too low, increase the value appropriately.
- (5) If the problem still persists, contact **RIGOL**.

**3. The constant current output is abnormal.**

- (1) Check whether the max output power meets the load requirement.
- (2) Check whether there is a broken circuit across the cable that connects the load and the power supply, and check whether the connection is in good condition.
- (3) Check whether there is a problem with the load.
- (4) Check whether the voltage setting value is proper. If the value is too low, increase the value appropriately.

(5) If the problem still persists, contact **RIGOL**.

**4. The screen display is too dark.**

- (1) Press **System** to enter the system utility function interface. Press the Left/Right arrow key or use the knob to select the "Setting" tab.
- (2) In the system setting tab, press the Up/Down arrow key to switch the parameter focus to "Brightness", and then use the num key or knob to adjust the brightness to a proper state.

**5. How do I switch the system language?**

- (1) Press **System** to enter the system utility function interface. Press the Left/Right arrow key or use the knob to select the "Setting" tab.
- (2) In the system setting tab, press the Up/Down arrow key to switch the parameter focus to "Language", and then press the Left/Right arrow key or use the knob to select the desired language.

**6. The RS232 interface cannot work normally.**

- (1) Check whether the RS232 cable is straight-through and whether it is intact.
- (2) Check whether the current RS232 settings of the software match those of the instrument.
- (3) If the problem still persists, contact **RIGOL**.



## Chapter 5 Specifications

All the technical specifications are guaranteed when the instrument has been working for more than 30 minutes under the specified operating temperature.

DC Output (0°C to 40°C)		
Model	Voltage/Current Rating	OVP/OCP
DP711	0 V to 30 V/0 A to 5 A	0.01 V to 33 V/0.01 A to 5.5 A
DP712	0 V to 50 V/0 A to 3 A	0.01 V to 55 V/0.01 A to 3.3 A

Load Regulation, ±(% of Output + Offset)	
Voltage	<0.01% + 2 mV
Current	<0.01% + 2 mA

Line Regulation, ±(% of Output + Offset)	
Voltage	<0.01% + 2 mV
Current	<0.01% + 2 mA

Ripple and Noise (20 Hz to 20 MHz)		
Model	Normal Mode Voltage	Normal Mode Current
DP711	<500 $\mu$ Vrms/3 mVpp	<2 mArms
DP712	<500 $\mu$ Vrms/4 mVpp	

Annual Accuracy <sup>[1]</sup> (25°C ± 5°C), ±(% of Output + Offset)		
Programming	Voltage	0.05% + 20 mV
	Current	0.2% + 10 mA
Readback	Voltage	0.05% + 20 mV
	Current	0.2% + 20 mA

Resolution		
Programming	Voltage	Standard: 10 mV High resolution option installed: 1 mV
	Current	Standard: 10 mA High resolution option installed: 1 mA
Readback	Voltage	Standard: 10 mV High resolution option installed: 1 mV
	Current	Standard: 10 mA High resolution option installed: 1 mA
Display	Voltage	Standard: 10 mV High resolution option installed: 1 mV
	Current	Standard: 10 mA High resolution option installed: 1 mA

**Transient Response Time**

Less than 50  $\mu$ s for output voltage to recover to within 15 mV following a change in output current from full load to half load or from half load to full load.

**Command Processing Time<sup>[2]</sup>**

<100 ms

**OVP/OCP**

Accuracy, $\pm$ (% of Output + Offset)	0.5% + 0.5 V/0.5% + 0.5 A
OVP Activation Time	<10 ms (OVP>1 V)

**Voltage Programming Speed<sup>[3]</sup> (within 1% of the total variation range)**

Up	Full Load	150 ms
	No Load	100 ms
Down	Full Load	30 ms
	No Load	450 ms

**Temperature Coefficient<sup>[4]</sup>,  $\pm$ (% of Output + Offset)**

Voltage	0.01% + 2 mV
Current	0.02% + 3 mA

**Stability<sup>[5]</sup>,  $\pm$ (% of Output + Offset)**

Voltage	0.02% + 2 mV
Current	0.1% + 3 mA

**Mechanical**

Dimensions	140 mm (W) x 202mm (H) x 332 mm (D)
Weight	Net: 6.9 kg

**Power**

AC Input Power (50 Hz to 60 Hz)	100 Vac $\pm$ 10%, 120 Vac $\pm$ 10%, 220 Vac $\pm$ 10%, and 240 Vac $\pm$ 10% (max: 253 Vac)
Maximum Input Power	400 VA

**Interface**

RS232	1 (Male)
-------	----------

**Environment**

Cooling Method	Fan Cooled
Operating Temperature	0°C to 40°C for full rated output

---

Maximum Output Floating Voltage to Ground	$\pm 240$ Vdc
Storage Temperature	-40°C to 70°C
Humidity	5% to 80% RH
Altitude	Below 2,000 m

---

**Note**<sup>[1]</sup>: The accuracy parameters are acquired through calibration under 25°C after 1-hour warm-up.

**Note**<sup>[2]</sup>: The maximum time required for the output to begin to change after receiving the APPLy and SOURce commands.

**Note**<sup>[3]</sup>: Exclude the command processing time.

**Note**<sup>[4]</sup>: Maximum change in output/readback per °C after a 30-minute warm-up.

**Note**<sup>[5]</sup>: Following a 30-minute warm-up, change in output over 8 hours under constant load, line, and ambient temperature.



## Chapter 6 Appendix

### Appendix A: Order Information

	Description	Order No.
<b>Model</b>	Programmable Linear DC Power Supply (single channel, 30 V/5 A)	DP711
	Programmable Linear DC Power Supply (single channel, 50 V/3 A)	DP712
<b>Standard Accessories</b>	Power Cord	-
	Either one of the following specified fuses: <ul style="list-style-type: none"> <li>● Fuse 50T-050H 250V 5A (AC Selector: 100 Vac or 120 Vac)</li> <li>● Fuse 50T-025H 250V 2.5A (AC Selector: 220 Vac or 240 Vac)</li> </ul>	-
	Quick Guide (hard copy)	-
<b>Optional Accessories</b>	High Resolution	HIRES-DP700
	Trigger (external synchronous trigger input and output)	TRIGGER-DP700
	Timer	TIMER-DP700
	9-Pin RS232 Cable (female-to-female, straight)	CB-DB9-DB9-F-F-150
	DP700 Series Rack Mount Kit (for a single instrument)	RM-1-DP700
	DP700 Series Rack Mount Kit (for two instruments)	RM-2-DP700
DP700 Series Rack Mount Kit (for three instruments)	RM-3-DP700	

**Note:** For all the accessories and options, please contact the local office of **RIGOL**.

## Appendix B: Warranty

**RIGOL** TECHNOLOGIES, INC. (hereinafter referred to as **RIGOL**) warrants that the product will be free from defects in materials and workmanship within the warranty period. If a product proves defective within the warranty period, **RIGOL** guarantees free replacement or repair for the defective product.

To get repair service, please contact with your nearest **RIGOL** sales or service office.

There is no other warranty, expressed or implied, except such as is expressly set forth herein or other applicable warranty card. There is no implied warranty of merchantability or fitness for a particular purpose. Under no circumstances shall **RIGOL** be liable for any consequential, indirect, ensuing, or special damages for any breach of warranty in any case.

# Index

- AC selector..... 1-11
- air outlet..... 1-10
- appearance and dimensions..... 1-3
- beeper..... 2-28
- built-in help..... 1-17
- CC..... 2-5
- constant current output..... 2-5
- constant voltage output..... 2-2
- CV..... 2-2
- default settings..... 2-24
- end state ..... 2-12
- file deletion..... 2-22
- file recalling ..... 2-22
- file storage..... 2-21
- front panel..... 1-4
- front panel locking ..... 2-37
- function keys..... 1-4
- fuse..... 1-17
- general inspection..... 1-2
- key locking..... 2-38
- LCD..... 1-4
- license ..... 2-35
- manual calibration ..... 2-33
- number of cycles ..... 2-11
- number of output groups..... 2-11
- option..... 2-35
- option license ..... 2-35
- order information..... 6-1
- output check ..... 1-15
- output terminals ..... 1-6
- parallel connected power supply .. 2-9
- parameter setting method..... 1-18
- power-on inspection ..... 1-14
- power-on setting ..... 2-27
- rear panel..... 1-10
- remote control ..... 3-1
- remote locking ..... 2-37
- RS232 Interface ..... 2-30
- screen saver ..... 2-28
- series connected power supply .... 2-8
- specifications ..... 5-1
- store and recall ..... 2-20
- switch lever ..... 1-11
- synchronous output..... 2-17
- system information..... 2-32
- system language ..... 2-27
- system setting ..... 2-27
- system utility function..... 2-26
- test and calibration..... 2-33
- timer ..... 2-10
- timer parameters..... 2-11
- timing output ..... 2-14
- trigger..... 2-16, 2-28
- trigger input ..... 2-16
- trigger mode..... 2-11
- trigger output ..... 2-17
- troubleshooting ..... 4-1
- UR ..... 2-2
- user interface..... 1-12
- user-defined programming ..... 3-1